

MCWP 3-16.6"
Y IGttcwo

Supporting Arms Observer, Spotter and Controller



U.S. Marine Corps

DISTRIBUTION STATEMENT A: Approved for public release, distribution is unlimited.

PCN 143 000060 00

ERRATUM

**In MCWP 3-16.6, *Supporting Arms
Observer, Spotted and Controller,*
Dated 20 November 1998**

Page 8-13, line 17:

portion of the aircraft's approach phase, specifically
from two minutes before the CAS TOT\TTT until
one minute before the CAS TOT\TTT.

SHOULD READ:

portion of the aircraft's approach phase, specifically
from 1 minute before the CAS TOT\TTT until
30 seconds before the CAS TOT\TTT.

DEPARTMENT OF THE NAVY
Headquarters United States Marine Corps
Washington, DC 20380-1775

15 October 1998

FOREWORD

1. PURPOSE

Marine Corps Warfighting Publication (MCWP) 3-16.6, *Supporting Arms Observer, Spotter, and Controller*, provides the techniques and procedures for requesting and adjusting supporting arms.

2. SCOPE

This publication provides techniques and procedures for requesting, adjusting, and controlling mortars, artillery, naval gunfire, and close air support. It is intended as a field reference for supporting arms observers (mortar and artillery forward observers, naval gunfire spotters, and forward air controllers) and as a study guide and field reference for personnel seeking information on supporting arms procedures.

3. SUPERSESSION

Fleet Marine Force Manual (FMFM) 6-8, *Supporting Arms Observer, Spotter, and Controller*, dated 24 June 1994.

4. CERTIFICATION

Reviewed and approved this date.

BY DIRECTION OF THE COMMANDANT OF THE MARINE CORPS

J.E. RHODES
Lieutenant General, U.S. Marine Corps
Commanding General
Marine Corps Combat Development Command

DISTRIBUTION: 143 000060 00

To Our Readers

Changes: Readers of this publication are encouraged to submit suggestions and changes that will improve it. Recommendations may be sent directly to Commanding General Marine Corps Combat Development Command, Doctrine Division (C42), 3300 Russell Road, Suite 318A, Quantico, VA 22134-5021 or by fax to (703) 784-2917 (DSN 278-2917) or e-mail to **smb@doctrine div@mccdc**. Recommendations should include the following information:

- Location of change
 - Publication number and title
 - Current page number
 - Paragraph number (if applicable)
 - Line number
 - Figure or table number (if applicable)
- Nature of change
 - Add, delete
 - Proposed new text, preferably double spaced and typewritten
- Justification and/or source of change.

Additional copies: A printed copy of this publication may be obtained from Marine Corps Logistics Base, Albany, GA 31704-5001, by following the instructions in MCBul 5600, *Marine Corps Doctrinal Publications Status*. An electronic copy may be obtained from the Doctrine Division, MCCDC, World Wide Web home page, which is found at the following uniform resource locator:
<http://138.156.107.3/docdiv>.

Unless otherwise specified, masculine nouns and pronouns used in this publication refer to both men and women.

(reverse blank)

Record of Changes

Change Number	Date of Change	Date of Entry	Organization	Signature

(reverse blank)

Introduction

The technology and organizations for providing supporting arms today are products of our training and operational experience over the past 100 years. Initial techniques for controlling fires of artillery and naval rifles were limited to direct fire, where the crew of the weapon had to see the target. This was primarily because of the lack of a long-range observation and communications capability. These crude measures for controlling fires could prove hazardous to friendly as well as enemy forces, as the Marines found out during operations in Cuba during the Spanish-American War.

On June 14 [1898] Captain George F. Elliott led two infantry companies and a detachment of fifty Cuban scouts on a circular six-mile march toward Cuzco Well [location of a Spanish camp]. Although the Marines did not surprise the Spanish garrison of battalion strength, they won the foot race to the hill that dominated the Spanish camp and caught the enemy in the valley. At ranges up to 1,000 yards the Marines peppered the Spaniards with rifle and machine gun fire. During the fighting another Marine platoon on outpost duty on its own initiative closed off the head of the valley and caught the enemy in a crossfire, while the dispatch ship Dolphin added its shells to the general firing. The Dolphin's shells, fired without much direction, also drove the Marine platoon from its position until the shelling was stopped by a wigwag message from Sergeant John H. Quick.¹

Experiences in the first World War exposed Marines to the realities of trench warfare with modern weapons. Potent fire support was crucial to advancing against an enemy who was firmly entrenched in

supporting defensive positions. This support was provided by U.S. Army and allied artillery because Marine artillery units did not deploy to France.² Although techniques for controlling indirect fire had progressed, their responsiveness and flexibility in changing situations were still hampered by a lack of portable, reliable communications. This deficiency would eventually be overcome by the introduction of tactical radios.

Marine aviation began in 1913 when 1stLt Alfred A. Cunningham was designated as naval aviator number 5. Marine aviation's first involvement in combat occurred in the latter part of World War I during which it conducted aerial observation and bombing missions as part of the Allied air effort. Marine aviation's first independent mission was flown in 1918 against a German-held railyard in Belgium.³ Marine aircraft were used for a variety of missions from resupplying remote patrols and outposts to providing close air support (CAS) to ground units in the "Banana Wars" during the 1920s. Communications between ground forces and aircraft, although generally effective against the guerrillas, were anything but sophisticated.

Although Marine aircraft were equipped with radio, the prohibitive weight of early sets, coupled with the poor transmission characteristics amid the terrain of Nicaragua meant that most were removed from planes to permit carrying more fuel and weapons. "Communication with ground troops," then-Captain Mathew B. Ridgeway, an Army observer in Nicaragua, reported, "has been almost entirely by Very Pistol, pick-up and drop messages, and panels."⁴

The lessons learned from using aircraft to attack ground targets and the need for close coordination between the Marine in the air and the Marine on the ground during these actions were reflected in the Marine Corps *Small Wars Manual* of 1940.

In order to secure the full measure of cooperation between the air and ground forces, it is necessary that each understands the problems of the other. The aviator must know something of the tactics of the ground patrol, and he must be ready and willing to assume any justified risk to assist the ground commander. On the other hand, the ground commander should understand the hazards and limitations imposed on aviation operating over difficult terrain, and should not expect the impossible.⁵

This sense of teamwork and the initial procedures for controlling CAS developed between the World Wars would be put to the test during operations in the Pacific during World War II.

World War II provided Marines with the opportunity to make major developments in the techniques for controlling supporting arms. It was an evolutionary process. Marine artillery expanded from the organic regiments of each division to include heavy artillery assigned to the amphibious corps. Marine artillery was used to provide direct fire on enemy bunkers throughout the war, and forward observers (FOs) called for and adjusted indirect fire in support of maneuver units.

Recognizing the need to improve the employment of naval gunfire (NGF) in support of Marine ground forces, LtGen Holland Smith organized an NGF section at V Amphibious Corps in late 1943.

...the Naval Gunfire Section turned Kahoolawe Island, Hawaii, into a ship gunnery school and eventually supervised the qualification firing for 532 Pacific Fleet warships. The training exercises dramatized the need for intelligent gunfire spotting. The NGF Section first stressed putting trained Marine ground officers into spotting aircraft but then shifted to training Navy and Marine officer spotting teams for ground employment.⁶

In October of 1944, LtGen Smith formed the Marine Air Support Control Unit, which was commanded by Col Vernon Megee. The unit provided CAS training and expanded the ability of landing force commanders to plan and direct airstrikes.

The final step in improving close air support—actually directing the strikes from the front lines against targets close to friendly troops—also originated with Megee's command. Equipped with improved jeep-mounted radios, Marine air controllers argued, they could direct strikes against ground targets within hundreds (rather than thousands) of yards of American troops by communicating directly with the aircraft. This technique, which ran counter to Navy and Army doctrine, required air strike controllers well versed in ground tactics and aircraft capabilities. At first the forward air controllers were air-indoctrinated ground officers, but the Air Liaison Parties (ALPs) soon became the instrument of pilots-turned-infantrymen. This reform proved successful for the Army in the Philippines and the Marine Corps on Okinawa.⁷

These techniques for effectively coordinating and controlling the fires from various fire support agencies (mortars, artillery, NGF, and CAS) reflected the lessons learned from three years of intense combat across the Pacific and formed the basis for the Marine

Corps' current procedures for controlling supporting arms. Although they would continue to be refined, the basic concepts have remained valid to this day. Although the use of semaphore has given way to data burst transmissions, the requirement for a Marine who is capable of controlling the fires of supporting arms remains crucial to success in combined-arms operations.

This publication contains the techniques and procedures used by artillery and mortar FOs, NGF spotters, and forward air controllers (FACs) to request, adjust, and control supporting arms. It is no accident that the techniques for these three supporting arms are covered in the same publication. The doctrine of combined arms requires the full integration of arms. We take advantage of the complementary capabilities of different types of supporting arms to enhance mobility and firepower. To avoid the effects of one arm, the enemy makes himself vulnerable to another. Achieving proficiency in combined arms requires a building-block approach to training that progresses from individual skills to unit skills and culminates at the Marine air-ground task force (MAGTF) level. Supporting arms observers, spotters, and controllers should be cross-trained in the techniques contained in this publication (i.e., the FOs should be trained to control CAS just as FACs should be capable of calling for and adjusting artillery and NGF). The techniques explained in this publication are fundamental for employing Marine Corps fire support. The most detailed and thorough fire support plans are useless without Marines who are skilled in the techniques and procedures for bringing the effects of firepower down on the enemy.

Supporting Arms Observer, Spotter, and Controller

Table of Contents

		Page
Introduction		
Chapter 1. Supporting Arms Observers, Spotters, and Controllers		
Section I. Artillery Forward Observer Team		
1101	Responsibilities	1-2
1102	Communications	1-5
Section II. 81-mm Mortar Forward Observer		
1201	Responsibilities	1-9
1202	Communications	1-10
Section III. Naval Gunfire Spot Team		
1301	Responsibilities	1-11
1302	Communications	1-12

Section IV. Forward Air Control Party

1401	Responsibilities	1-14
1402	Communications	1-15

Section V. Employing Supporting Arms Observers, Spotters, and Controllers

1501	Offensive Operations	1-18
1502	Defensive Operations	1-21
1503	Patrols	1-22
1504	Retrograde Operations	1-22

Chapter 2. Target Location**Section I. Elements and Tools of Target Location**

2101	Map Reading	2-1
2102	Direction	2-2
2103	Determining Angular Deviation	2-7
2104	Distance	2-11
2105	Altitude	2-18
2106	Tools To Assist the Observer	2-19

Section II. Methods of Target Location

2201	Polar Plot	2-35
2202	Grid Coordinates	2-38
2203	Shift From a Known Point	2-39

Chapter 3. Requesting and Adjusting Artillery, Mortars, and Naval Gunfire

Section I. Artillery and Mortar Call for Fire

3101	Elements of the Call for Fire	3-1
3102	Observer Identification and Warning Order	3-2
3103	Target Location	3-4
3104	Target Description, Method of Engagement, and Method of Fire and Control	3-6
3105	Call for Fire for Suppressive Fire	3-16
3106	Direction	3-18
3107	Message to Observer	3-18
3108	Authentication	3-21
3109	Report Upon Firing	3-23
3110	Correction of Errors	3-34
3111	Call for Fire From Headquarters Higher Than Battalion	3-24

Section II. Naval Gunfire Call for Fire

3201	Fire Unit Status	3-25
3202	Elements of the Call for Fire	3-25
3203	Spotter Identification, Warning Order, and Target Number	3-26
3204	Target Location, Target Description,	3-27

Method of Engagement, and Method of Control

3205	Report Upon Firing	3-39
3206	Correction of Errors	3-39

Section III. Adjustment of Fire

3301	Spottings	3-41
3302	Corrections	3-47
3303	Fire-for-Effect Phase	3-57
3304	Naval Gunfire Adjustment Procedures	3-61
3305	Adjusting Artillery Air Bursts	3-64
3306	Adjusting Naval Gunfire Air Bursts	3-68

Chapter 4. Requesting and Controlling Close Air Support

4001	Types of Close Air Support	4-1
4002	Levels of Threat	4-2
4003	Airspace Control Measures	4-3
4004	Coordination Techniques	4-7
4005	Aircraft Ordnance	4-9
4006	Close Air Support Request and Control Procedures	4-13
4007	Request	4-13
4008	Brief	4-22
4009	Time	4-24
4010	Mark, Adjustment, and Control of Initial Aircraft	4-27

4011	Adjustment and Control of Subsequent Aircraft	4-33
4012	Reattacks	4-33
4013	Reasonable Assurance	4-34
4014	The Report	4-35
4015	Air-Delivered Ordnance in Vicinity of Friendly Troops	4-36
4016	Emergency Procedures for Requesting Close Air Support	4-38

Chapter 5. Artillery and Mortar Special Situations

Section I. Artillery and Mortar High-Angle Fire

5101	Procedures	5-1
------	------------	-----

Section II. Artillery and Mortar Precision Fire

5201	Artillery Registration Missions	5-2
5202	Precision Registration for Mortars	5-13
5203	Destruction Missions	5-16

Section III. Artillery High-Burst or Mean Point of Impact Registrations

5301	General	5-18
5302	Procedures for High-Burst Registration	5-19
5303	Procedures for Mean Point of Impact Registration	5-25

Section IV. Artillery Improved Conventional Munitions

5401	Antipersonnel Round	5-26
5402	Dual-Purpose Round	5-27
5403	Dispersion	5-28
5404	Improved Conventional Munitions Call for Fire and Adjustment	5-29
5405	Employment Considerations	5-32

Section V. Artillery Family of Scatterable Mines

5501	Remote Antiarmor Mine System Projectiles	5-33
5502	Area Denial Artillery Munitions Projectiles	5-33
5503	Types of Minefields	5-34
5504	Target Location	5-35
5505	Family of Scatterable Mines Call for Fire and Adjustment	5-36
5506	Employment Considerations	5-37

Section VI. Artillery and Mortar Illumination

5601	Employment of Illumination	5-38
5602	Illumination Patterns	5-39
5603	Illumination Call for Fire and Adjustment	5-42
5604	Coordinated Illumination	5-45
5605	Continuous Illumination	5-47

Section VII. Smoke

5701	Categories of Smoke	5-48
5702	Battlespace Applications	5-48
5703	Delivery Systems	5-49
5704	Smoke Planning Considerations	5-52
5705	Types of Smoke Missions	5-62
5706	Safety Considerations	5-72

Section VIII. Artillery and Mortar Final Protective Fires

5801	Employment of Final Protective Fires	5-74
5802	Final Protective Fire Procedures	5-74

Section IX. Nonstandard Procedures for Artillery and Mortars

5901	Adjustment of Fires by Sound	5-79
5902	Multiple Missions	5-81
5903	Auxiliary Adjusting Point	5-81
5904	Disoriented Observer	5-82
5905	Irregular-Shaped Targets	5-83
5906	Emergency Observer Procedures	5-85

Chapter 6. Naval Gunfire Special Situations

6001	Illumination	6-1
6002	Smoke	6-8
6003	Fresh Target Shift	6-8
6004	New Target Shift	6-12

6005	Simultaneous Engagement of Two Targets	6-12
6006	Firing on a Recorded Target	6-13
6007	Destructive Fire	6-14
6008	Massed Fire	6-14
6009	Special Naval Gunfire Commands and Reports	6-15

Chapter 7. Aerial Observation

7001	Aerial Observer	7-1
7002	Prelaunch Considerations	7-1
7003	Reporting In and Out	7-2
7004	Call for Fire	7-6
7005	Adjustment of Fire	7-9
7006	Forward Looking Infrared Receiver	7-10
7007	Laser Designators	7-11

Chapter 8. Suppression of Enemy Air Defenses

8001	SEAD Coordination	8-1
8002	Planned SEAD Missions	8-2
8003	Immediate SEAD Missions	8-2
8004	SEAD Decisionmaking	8-3
8005	Separation Techniques	8-6
8006	Airspace Control Measures	8-17
8007	Target Marking for Close Air Support Aircraft	8-18

8008	Artillery SEAD	8-20
8009	Naval Gunfire SEAD	8-29

Chapter 9. Laser Designators and Laser-Guided Weapons Systems

9001	Purpose	9-1
9002	Basic Requirements	9-1
9003	Laser Emission Systems	9-2
9004	Laser Acquisition Devices	9-4
9005	Laser-Guided Munitions	9-5
9006	Laser Energy Reflectivity	9-7
9007	Laser-Guided-Munition Planning	9-13
9008	Methods of Employment	9-18
9009	Employment Considerations	9-19
9010	Copperhead Engagement Characteristics	9-22
9011	Copperhead Call for Fire	9-30
9012	Message to Observer	9-33
9013	Trigger Points	9-33
9014	Copperhead Engagement Commands	9-37
9015	Survey Control	9-39
9016	Laser Polar Missions	9-48
9017	Target Shifts	9-50
9018	Registrations with MULEs	9-51
9019	MULE Employment by the Naval Gunfire Spot Team	9-52
9020	AN/GVS-5 Laser Rangefinder Employment	9-53

Appendixes:

A	Target Analysis and Munitions Effects
B	Crater Analysis
C	Observation Post
D	Timing the Delivery of Fire Support
E	Construction of the Visibility Diagram
F	Weapons Reference Data
G	Glossary
H	Notes

Chapter 1

Supporting Arms Observers, Spotters, and Controllers

The Marine Corps has four organizations that provide a maneuver company with observers, spotters, and controllers who are specifically trained to plan, call for, adjust, and control supporting arms. They are the artillery FO team, 81-mm mortar FO, NGF spot team, and forward air control party (FACP). Whether a company has one organization or all four attached for an operation (or phase of an operation) depends on the situation and mission.

Section I. Artillery Forward Observer Team

Each firing battery of the artillery battalion has three FO teams. One of these teams is provided to each company-sized unit/element of the supported force. The number of FO teams may vary with the composition of the force and structure limitations. The FO team is led by a Marine lieutenant who is trained in fire support coordination and advises the company commander on the employment of fire support assets. The FO team plans and coordinates artillery fires with the fires of other supporting arms at the company level. It is trained to adjust artillery, rockets, mortars, and NGF, as well as report battlespace information. The FO team can operate within a maneuver element or from an artillery observation post (OP).

An FO team's composition may vary with the mode of operation, availability of personnel, and type of force supported, for example, a mechanized unit with limited vehicle space or with a footmobile unit. (See table 1-1 below and table 1-2 on page 1-3 for the personnel and notional equipment of an FO team.)

Table 1-1. Artillery Forward Observer Team Personnel.

Position/Rank/Military Occupational Specialty (MOS)	Number
FO/lieutenant/0802	1
Fire support man/lance corporal/0861	1
Radio operator/corporal/2531	1
Radio operator/private/2531	1

1101. Responsibilities. The primary responsibility of the FO is to plan and coordinate supporting fires at the company level. The FO team locates targets, calls for and adjusts fire, and reports the results of fire. In combat or emergency situations when there is no FAC present, the FO may function as the terminal controller for CAS strikes. The FO team must perform the following tasks:

- Assist the commander in overall fire support planning and coordination matters.
- Advise the commander on the employment of artillery. The FO must know how much and what type of artillery and/or ammunition is available. He should be prepared to advise on all types of indirect fire support.

Table 1-2. Notional Artillery Forward Observer Team Equipment.

Notional Equipment	Number
High mobility multipurpose wheeled vehicle (HMMWV) ¹	1
AN/PRC-119A Single-channel Ground and Airborne Radio System (SINCGARS) radio	2
AN/GRA-39 set ¹	1
OH-254 antenna ¹	1
Digital message system/data automated communications terminal (DACT)	2
Precise lightweight Global Positioning System (GPS) receiver (PLGR)	1
AN-PAQ 3 modular universal laser equipment (MULE) ¹	1
AN/GVS-5 laser rangefinder	1
Battery commander (BC) scope	1
Binoculars	2
Compass	2
Night vision goggles (NVGs) AN/PVS-7B ²	1
Legend:	
¹ Optional.	
² Other night vision devices may be available.	

- Plan artillery fires for the company. This includes normal and quick fire planning. The plan is approved by the company commander.

1-4

- Be familiar with standing operating procedures (SOPs) of the supported and supporting unit, including fire support SOPs and the company's combat SOP.
- Know the tactical situation, including the scheme of maneuver or plan of defense, and the enemy situation.
- Maintain continuous observation of the zone. The zone of observation is the zone of action of the supported unit or the zone of fire of the parent battalion. The FO team must occupy the best OP or position permitted by the tactical situation.
- Determine and refine target locations, engagement criteria, and trigger points as required.
- Make a terrain sketch of the area, whenever possible, to improve accuracy and speed in locating targets. When setting into a defensive position, the FO should construct a visibility diagram to pinpoint those areas where targets could remain unseen from his vantage point. See appendix E for construction of a visibility diagram.
- Report all target and intelligence information by using the size, activity, location, unit, time, and equipment (SALUTE) format and report actions of enemy aircraft and conduct crater analysis.
- Ensure constant communications with the battery or battalion fire direction center (FDC) and the liaison officer (LNO) in the battalion fire support coordination center (FSCC).

- Keep the FDC and artillery LNO at the battalion FSCC informed of the tactical situation, the plans, and the location of the supported unit.
- Maintain the FO team location to within 100 meters (six-place grid) at all times. Periodic position reports (POSREPs), coordinated with the reporting of the company commander, should be made to the LNO. In the absence of a unit SOP or special instructions, a rule of thumb for reporting position changes is every 500 meters on foot or every 2 to 5,000 meters in a fast-moving operation.
- Provide security for the team through the proper use of cover, concealment, observation, and fire.
- Conduct regular preventive maintenance of all equipment belonging to the FO team.
- Observe and direct other types of fire support when necessary, for example, mortars, NGF, and CAS.
- Assist in training Marines with nonsupporting arms MOSs to request fire support, if required.

1102. Communications. The artillery FO must maintain effective communications to perform his mission. He has several means available.

a. Radio. The FO team uses radio traffic as its primary means of communication. All members of the team must be communications experts; they must maintain the gear to the highest degree of

performance, troubleshoot, and enhance performance when possible through the use of directional antennas and so on. The following nets are employed by the FO team.

(1) Artillery Conduct of Fire Net (Very High Frequency). This net provides a means for observers to request and adjust artillery fire. The artillery LNOs at battalion FSCCs monitor/receive traffic on the net for fire support coordination purposes. FOs and LNOs may use the net to plan and coordinate fires. If conducting *battalion-directed* operations, the battalion establishes as many as three conduct of fire (COF) nets and acts as net control on each. The artillery battalion may identify a COF net for each maneuver battalion to facilitate continuity of fire support during battery displacements. The maneuver battalion (LNOs, FOs) remains on the assigned COF net, and the artillery battalion FDC receives all calls for fire. It then designates which firing battery, or batteries, will provide fire support to the maneuver battalion. This allows the artillery battalion to quickly mass on larger targets, as well as manage the assets of the battalion as a whole. If conducting *autonomous operations*, each battery FDC maintains a COF net and acts as net control; each net is monitored by the battalion FDC when present. Autonomous operations are also conducted by batteries attached to a battalion landing team (BLT). The artillery LNO at the battalion FSCC monitors all traffic on this net for coordination purposes. The artillery LNO at the infantry regiment may enter the net, as required. The stations on this net include the following:

- Direct support artillery battalion headquarters

- Firing battery
- Artillery LNO at battalion FSCC
- FOs
- Artillery LNO at regimental FSCC, as required
- Reinforcing artillery units, as required.

(2) Division/Ground Combat Element Artillery Air Spot Net (Very High Frequency). The artillery regiment (battalion when operating independently) establishes this net for aerial observers to adjust artillery fire. The artillery regiment is net control; however, for a specific mission, control may be passed to the battalion or battery FDC conducting the mission. When this net is in use, the LNO monitors for targets in his unit's zone. The FO may use this net to coordinate with an aerial observer for the attack of targets in his company's zone of action. The stations on this net include the following:

- Artillery regiment (net control) (For specific missions, control may be passed to the FDC conducting the mission (battalion or battery).)
- Aerial observer
- Artillery battalion, as required
- Firing battery, as required

- FOs, as required
- FSCCs, as required.

(3) Maneuver Tactical (Company Tactical) Net (Very High Frequency). Monitoring maneuver tactical nets is not a requirement for the FO team. However, the ability to monitor multiple channels with the PRC-119 enables the FO team to use company nets to increase situational awareness without requiring additional radios.

b. Automated Systems. Handheld devices, such as the digital message system or DACT, enable users to rapidly prepare, transmit, and receive both text and graphic messages over radios or field wire. Automated systems use a burst transmission capability, which minimizes vulnerability to enemy radio direction finding. It is used by the FO to transmit calls for fire, fire plans, and battlespace information. The DACT is currently being fielded, and fire support software is under development. When using automated systems, the FSCC establishes a mode of operation, which determines the routing of calls for fire through the FSCC. In FSCC-approval mode, the call for fire is sent to the FSCC for clearance then forwarded to the supporting arm. In centralized mode, the request goes to the appropriate artillery FDC first. One or more COF nets should be dedicated to data communications. Note that the artillery battalion still organizes itself to receive missions by using battalion-directed and autonomous operations.

c. Wire. The FO uses wire communications to the extent permitted by the tactical situation, time, and personnel available. In a static defensive posture, a land line may be used between the company

commander and a remote OP. Wire may be used between the FO and his fire support man when operating separately.

d. Messenger. The FO uses this method of communication frequently when tactical situations permit. This method is a more secure method of sending fire plans than other means. It reduces radio traffic, thereby hampering enemy direction finding.

Section II. 81-mm Mortar Forward Observer

Two FOs are included in each of the two sections of the 81-mm mortar platoon that is organic to the weapons company of the infantry battalion. The infantry battalion commander may employ the mortar platoon by section or as a platoon. The mortar FOs are normally employed with the rifle companies. The mortar FO carries his own radio.

1201. Responsibilities. The primary responsibility of the mortar FO is to locate targets and call for and adjust mortar fire. He performs basically the same duties as the artillery FO. The mortar FO coordinates and plans the use of the mortars for the supported company. The operations of the mortar FOs are coordinated by the mortar platoon commander. A mortar representative is normally positioned in the battalion FSCC to coordinate and advise on matters concerning mortars.

1202. Communications. The infantry battalion mortar net (very high frequency (VHF)) provides the means for requesting, adjusting, controlling, and coordinating the fires of the 81-mm mortar platoon. Stations on this net include the FO(s), the 81-mm

mortar section FDC (platoon FDC when employed as a platoon), the 81-mm mortar representative in the battalion FSCC, and the mortar platoon commander (net control).

Section III. Naval Gunfire Spot Team

The NGF spot team is one element of the shore fire control party (SFCP); the other is a liaison team. The artillery battalion employs its two organic SFCPs in support of the assault battalions in an amphibious assault. The NGF spot team is normally provided to a maneuver company; however, it may operate from a battalion OP. The NGF spotter, a Marine lieutenant, is the company's expert on all matters concerning NGF support. Like the artillery FO team, its composition may be tailored to the needs of the supported unit. (See table 1-3 and table 1-4 on page 1-11 for the organization of the spot team and a list of notional equipment.)

Table 1-3. Naval Gunfire Spot Team Personnel.

Position/Rank/MOS	Number
NGF spotter/lieutenant/0845	1
SFCP man/corporal/0861	1
SFCP man/private - lance corporal/0861	1
Radio operator/private - corporal/2531	2

Table 1-4. Naval Gunfire Spot Team Notional Equipment.

Notional Equipment	Number
AN/PRC-104 radio ¹	1

AN/PRC-119 radio ¹	1
MULE ²	1
Laser AN/GVS-5	1
NVGs AN/PVS-7B ³	2
Binoculars	3
Compass	3
Legend: ¹ Includes KY-99 when NGF spot net is covered. ² Optional. ³ Other night vision devices may be used.	

1301. Responsibilities. The primary responsibility of the NGF spotter is to locate targets and call for and adjust NGF. The operation of the spot team is coordinated by the naval gunfire liaison officer (NGLO) in the battalion FSCC, assisted by the artillery S-3, as required. The NGF spotter performs other duties and operations similar to those of the artillery FO. The NGF spotter also performs the following tasks:

- Plans NGF to assist the company in accomplishing its mission
- Keeps the NGLO in the battalion FSCC informed of the company's tactical situation and the spot team disposition (Periodic POSREPs are provided to the NGLO and the ship.)
- Establishes and makes frequent contact with the other observers (artillery and mortar FOs) and the FAC supporting the company
- Remains abreast of what types of ship(s) and ammunition are available.

1302. Communications. The NGF spotter must have effective communications to accomplish his mission. He must understand the functioning of high frequency (HF) radio communications. The NGF spot team communicates by the following means.

a. Radio. The following nets are established.

(1) Naval Gunfire Ground Spot Net (Primary High Frequency/Secondary Very High Frequency). This net provides a means for requesting and adjusting NGF and for passing vital information between stations. Stations on this net include the NGLO in the battalion FSCC, the spotter, and the direct support ship. The NGLO, normally net control, monitors all traffic for purposes of coordination. One frequency is normally allocated to each battalion assigned a direct support ship. A general support ship assigned to support the battalion will enter the NGF ground spot net for the duration of the mission(s). The NGLO at the infantry regiment may monitor the net, as required.

(2) Shore Fire Control Party Local Net (Very High Frequency). This net provides direct communications between the NGF spot team and the NGLO in the battalion FSCC. It provides a means for coordinating the employment of the spot team and for coordinating NGF matters. The net is also used for communication between the NGF spotter and his spot team when separated. The NGLO exercises net control.

(3) Naval Gunfire Air Spot Net (Ultra High Frequency/Very High Frequency (Depends on Aircraft)). This net is used by an

aerial observer to request and adjust NGF. Stations on this net include any aerial observers and the supporting ship. The NGLO at the infantry battalion, regiment, and division enters this net. When an aerial observer is working in conjunction with ground units, the appropriate fire coordination agency will exercise net control. The supporting arms coordination center (SACC) is net control before transfer of control and coordination responsibilities ashore.

b. Wire. The spotter, like the artillery FO, has limited opportunities to use wire communications. When permitted by the situation, a land line is established between the NGF spotter and his SFCP men when operating separately and/or between the spotter's OP and the NGLO.

Section IV. Forward Air Control Party

The FACP is a terminal control agency subordinate to the tactical air control party (TACP). The TACP is the "subordinate operational component of a tactical air control system designed to provide air liaison to land forces and for the control of aircraft." (Joint Pub 1-02, *DOD Dictionary of Military and Associated Terms*) TACPs are integral elements of the Marine Air Command and Control System (MACCS) and are organic to infantry regiments and infantry, light armored reconnaissance (LAR), and tank battalions. Infantry and LAR battalion TACPs consist of an air party (air officer and communicators) and two FACPs that are typically attached to companies consistent with the commander's planned employment of aviation. The FACP is led by a FAC, who is "an officer (aviator/pilot) member of the tactical air control party

who, from a forward ground or airborne position, controls aircraft in close air support of ground troops.” (Joint Pub 1-02) Naval aviators or naval flight officers serving as FACs are formally trained to provide terminal control and are officially designated as FACs by MOS. (See Marine Corps Warfighting Publication (MCWP) 3-23.1, *Close Air Support*). In addition to the FAC, each FACP has four enlisted radio operators. Regimental TACPs do not have FACP. The tank battalion TACP includes two FACs but not the radio operators of the FACP.

1401. Responsibilities. Although not part of the aviation combat element (ACE), the FAC is an essential MACCS element. FACs are the primary terminal controllers of aircraft providing direct air support to task-organized maneuver elements. The FAC maintains radio communications with assigned support aircraft from a forward ground position. From this position, the FAC directs each CAS aircraft in its run on the target. This control aids target identification and enhances troop safety. The FAC may employ a laser system for designating targets. The primary duties of the FAC are as follows:

- Control aircraft during the terminal phase of CAS missions to assist in target identification and minimize the danger to friendly troops.
- Operate with the assault units of the battalion.
- Observe and locate targets of opportunity.
- Direct airstrikes against targets.

- Advise the supported company commander on the proper employment of aircraft assets.
- Gather and report all information of an intelligence nature, including target damage assessments.
- Stay abreast of the supported unit's plans, position, and needs.
- Stay abreast of the enemy situation, location of friendly units, and current target list.
- Request and control aircraft in accordance with the MAGTF air employment plan.

1402. Communications. The FAC maintains communications with the air officer located in the battalion FSCC and with the air control agency. He establishes and maintains positive communications with assigned support aircraft from his forward position. The FACP communicates by the following means.

a. Radio. The following nets are used.

(1) Tactical Air Request Net (High Frequency). This net provides a means for units to request immediate air support from an air control agency. The FSCC at each echelon monitors this net and coordinates with the air control agency to approve, deny, or modify the requests. Target damage assessments and emergency helicopter requests may also be passed over this net. Preplanned air support requests may, if necessary, be passed over the tactical air request

(TAR) net if other means are not available. The stations on this net include FACPs; the direct air support center (DASC); FSCCs; the Navy tactical air control center (TACC); tactical air coordinators (airborne) (TAC(A)s), FACs (airborne) (FAC(A)s), or other terminal controllers; assault support coordinators (airborne) (ASC(A)s); and other MAGTF agencies, as required.

(2) Tactical Air Direction Net (Primary Ultrahigh Frequency/Secondary Very High Frequency (Depends on Aircraft)). This net provides a means for directing aircraft in CAS missions by the terminal controller (e.g., FAC) and for the air control agency to brief support aircraft on target information and handoff to the terminal controller or TAC(A).

(3) Tactical Air Control Party Local Net (Very High Frequency). This net provides a means for coordination between the air officer in the battalion FSCC and the FACPs.

b. Related Aviation Nets. The FAC may function on the following nets, when required.

(1) Helicopter Request Net (High Frequency/Very High Frequency). This net provides a means for TACPs of helicopterborne forces to request immediate helicopter support from the DASC or the helicopter direction center (HDC).

(2) Helicopter Direction Net (Ultrahigh Frequency/Very High Frequency/High Frequency). This net provides positive control of inbound and outbound helicopters in the amphibious objective area (AOA).

c. Other Means. The FAC may require other means of communications. Other radio nets, existing land lines, or other means may be used.

Section V. Employing Supporting Arms Observers, Spotters, and Controllers

The employment of observers, spotters, and controllers is coordinated by the artillery LNO, NGLO, air officer, and 81-mm mortar representative at the supported-battalion FSCC. The artillery battalion S-3 may assist in this coordination, as required. During operations, supporting arms personnel should remain close to the company commander to provide assistance as needed, mainly because the commander receives reports from all elements of his unit and must decide where fire support is most urgently needed. If they must be separated from the commander, communications must be established between them. The FO and NGF spotter are assisted in their duties by fire support men. The fire support men can locate targets and call for and adjust fire. They also assist in fire planning. The fire support men can be collocated with the FO/NGF spotter during operations or located with a forward element or OP.

1501. Offensive Operations. In offensive operations, supporting arms personnel should be in position to maintain contact with the company commander and to see the battlespace. Depending on the nature of the mission and the situation, specific supporting arms personnel (i.e., FO, FAC, or NGF spotter) may need to be

collocated with the commander to maintain voice contact; because not all companies will have a FAC or NGF spotter, this may often be the FO. Fire support men from the FO team and/or NGF spot team may be located with the company's lead elements. In a mechanized unit, a designated individual (such as the FO) may be assigned a position on the commander's vehicle (tank or assault amphibious vehicle (personnel variant) (AAV(P))) from which he can operate (e.g., the loader's position on a tank). Fire support men may be similarly positioned with the lead platoon. Supporting arms personnel assist the supported unit commander in the offense by doing the following:

- Planning fires to support the company's attack and its reorganization following seizure of the objective (Fires are planned on confirmed and suspected enemy positions and key terrain. See MCWP 3-16, *Fire Support Coordination*, for detailed discussion on planning fires.)
- Executing the fire support plan
- Calling fire on targets of opportunity designated by the commander
- Providing battlespace information regarding the enemy situation
- Providing additional channels of communication
- Aiding in land navigation.

a. Movement to Contact. During these operations, supporting arms personnel perform the following tasks:

- Plan fires on critical points along the route of march
- Maintain their orientation by using land navigation skills and terrain features for reference points identifiable on the ground and on the map
- Conduct immediate action drills on contact
- Maintain continuous communications and provide periodic POSREPs to the FDC, LNOs, air officers, and other observers, as required, during movement.

b. Attack, Exploitation, and Pursuit. When enemy contact has been made, supporting arms personnel position themselves where they can best observe the actions of the supported unit, conduct fire missions, and coordinate fires for the company commander. The fire support men may be positioned on a terrain feature that offers good observation of the company's advance. The company commander is responsible for the fires of his company, including fire support. He either directs which targets to attack with fire support or approves missions. Supporting arms personnel must meet the following requirements:

- Be familiar with immediate action drills on contact (via SOP, operation order (OPORD), or situational reporting)
- Ensure that fires support maneuvering elements, that is, enable elements to close with and destroy or bypass the enemy

- Assess the benefit of fires versus their risk to friendly forces, for example, suppression versus minimum safe distance
- Consider the effects of shell/fuze combinations, for example, improved conventional munitions (ICM)
- Incorporate movement of elements into the delivery time of fires.

c. Consolidation. During consolidation on the objective, supporting arms personnel perform the following tasks:

- Send reports to the FDC, air officer, and LNOs, for example, situation reports (SITREPs) and new POSREPs
- Establish defensive fires and fires to disrupt an enemy counterattack in the fire plan
- Continue fire planning and make revisions/changes as necessary for the tactical situation
- Maintain continuous observation and fire support.

1502. Defensive Operations. Supporting arms personnel plan their fires to support the company's plan of defense. Artillery, mortar, NGF, and air fires are planned to break up the attack, repel the assault, limit or destroy penetrations, and support counterattacks. In the defense, supporting arms personnel perform the following tasks:

- Plan fires forward of, on, and behind the supported unit's defensive positions, including fires on obstacles and avenues of approach
- Plan final protective fires (FPFs) (artillery and mortars) and make adjustments if the situation permits
- Select an OP that provides good visibility of the company's area of responsibility (Fire support men may be positioned with the FO or NGF spotter, a platoon, or forward element.)
- Execute the fire plan, including battalion targets in the area of responsibility
- Construct a visibility diagram of the company's area of responsibility (artillery FO). (The diagram is prepared in duplicate; one copy is retained by the FO, and the other is forwarded through the artillery LNO to the battalion S-2. At the battalion level, coverage is planned for those areas not under ground observation. See appendix E.)

1503. Patrols. Providing fire support for friendly patrols is an important function for supporting arms personnel, particularly the artillery and mortar FOs. The FOs, FACs, and NGF spotters keep LNOs, air officers, and the FDC informed of friendly patrol plans. The FOs, FACs, and spotters may accompany the company commander on a patrol when the patrol consists of the major portion of the unit. Fire support men are normally positioned with the remainder of the company during their principal's absence. Fire support men may accompany a platoon or smaller sized patrol.

Supporting arms for the patrol are coordinated before the patrol begins. The planning by fire support personnel should include the following actions:

- Obtain from the company commander, along with the patrol leader, the size of the patrol, times of departure and return, mission, routes and checkpoints, and any special instructions.
- Assist the patrol leader in fire planning, following the guidance provided by the company commander. Fires are planned along the route on critical areas or key terrain by using priority targets when available.
- Process the fire plan. Provide a copy to the patrol leader. Obtain from the patrol leader any special communications instructions or signals to be used.
- Make arrangements to maintain communications, as required.

1504. Retrograde Operations. Selected supporting arms personnel (FO, FAC, or NGF spotter, depending on the situation) remain with the company commander throughout retrograde operations. The remainder of the teams displace with the withdrawing forces to maintain continuity of observation and fire. Fire support men may be employed in an overwatch position. Supporting arms personnel must perform the following tasks:

- Plan fires for the period during which the company has control of fires.

- Acquire and pass control of fires through the LNOs and air officer.
- Maintain observation of the area of responsibility during control of fires.
- Maintain orientation during movement.

(reverse blank)

Chapter 2

Target Location

Section I. Elements and Tools of Target Location

The observer's capability to provide the company with effective fire support depends largely on his ability to locate targets quickly and accurately. The elements of target location consist of direction, distance, and altitude. Terrain/map analysis is key to accurate target location. Because terrain/map analysis is applicable to the artillery/mortar FO, the NGF spotter, the FAC, and other terminal controllers, the use of the word *observer* in this chapter will apply to all of them.

2101. Map Reading. Understanding and applying the skills of map reading are essential to an observer's success. The observer will need these skills to perform terrain/map analysis. The observer's map is second in importance only to his radio. He uses his map to determine what terrain he expects to see in the battlespace. The observer continually scans the map and terrain and attempts to associate features that he sees on the ground with those on the map. The observer uses the map to determine the location of targets, friendly positions, and his own position and to keep oriented during movement. By using his map and other tools, he determines direction, distance, and altitude for target location. For a good terrain/map analysis, the observer performs the following tasks:

- Locates himself within 100 meters of his actual location on the ground each time he moves
- Uses prominent terrain features to relate potential target areas to grid locations on the map
- Makes a thorough study of terrain by drawing a terrain sketch
- Associates the direction in which he is looking with a direction on the map and incorporates the map's marginal information in orienting direction-determining tools.

2102. Direction. Direction is the most important element of target location and an integral part of terrain/map association and adjustment of fire. Direction is a term used by an observer to indicate the bearing of the spotting line.

a. Units of Measurement. Direction can be measured in mils or degrees. Degrees can be converted to mils when required.

(1) Mils. A mil is a unit of horizontal clockwise angular measurement that is equal to $1/6,400$ of a circle. The mil is normally used because of its accuracy and the mil relation formula's ability to easily convert angular deviation into distance. Mils may be measured from the map (grid north) or by using a compass (magnetic north). The standard unit of measurement is mils grid and need not be specified in the call for fire. Other units of measurement must be specified.

Example

“Direction 1600.” (Understood to be mils grid.)
“Direction 1600 mils magnetic.” (Unit of measurement must be specified if different from the standard.)

(2) Degree(s). A degree is a unit of horizontal clockwise angular measurement that is equal to 1/360 of a circle. Degrees can be measured from grid, magnetic, or true north. When the observer uses degrees in the call for fire, he must specify the type.

Example

“Direction 090 degrees magnetic.”

(3) Conversion of Degrees to Mils. Degrees may be converted to mils by multiplying the number of degrees by 17.8.

Example

90 degrees x 17.8 = 1,602 mils

b. Types of Direction. There are several types of direction that can be used by the observer—an observer-target line (OTL), a gun-target line (GTL), cardinal or intercardinal directions, and an arbitrary reference feature.

(1) Observer-Target Line. The OTL is “an imaginary straight line from the observer/spotter to the target.” (Joint Pub 1-02) It is the most commonly used direction for locating targets and conducting

adjustments. The standard unit of measurement is mils grid. Observer-target (OT) direction is determined as accurately as possible and transmitted to the nearest 10 mils (or nearest degree).

Example

A direction of 0642 mils would be transmitted as "direction 0640" (mils grid understood).

(2) Gun-Target Line. The GTL is "an imaginary straight line from the gun(s) to the target." (Joint Pub 1-02) GTL is frequently used by aerial observers as a spotting line for adjustments of fire. It can also be used by ground observers, particularly when positioned on or near the GTL. When the GTL is used as a direction, the standard unit of measurement is mils grid. If the observer desires to use the GTL as a spotting line, he transmits "direction gun-target line" in the call for fire.

(3) Cardinal or Intercardinal Directions. This involves the use of one of the eight cardinal/intercardinal directions (north, northeast, east, southeast, south, southwest, west, northwest). It is often used by aerial observers. It can also be used by ground observers, but the accuracy in adjustment is reduced. (See figure 2-1 on page 2-5.)

Example

"Direction northeast."

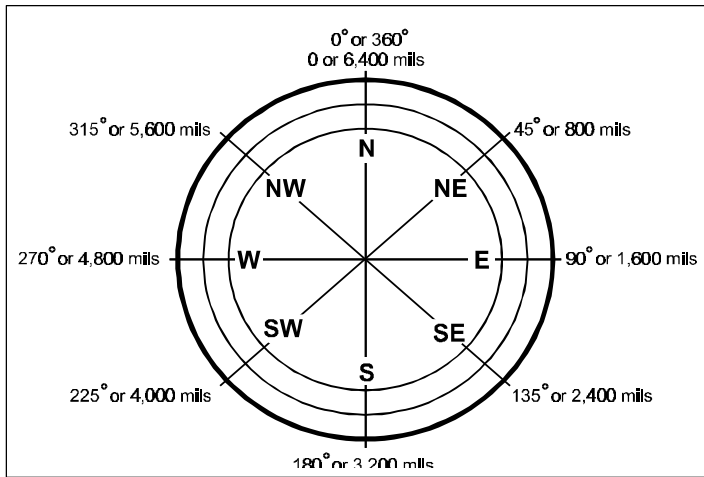

Figure 2-1. Cardinal Direction.

(4) Arbitrary Reference Feature. The observer may use a natural or manmade feature (such as north-south river or road) from which reference is made in target location and/or adjustment of fire. This type of direction may be used by aerial observers. It may also be used in situations in which the transmission of the OTL may compromise the ground observer's location. The observer may use an arbitrary feature to adjust fire.

Example

"Direction north-south road."

c. Determining Direction. There are four methods for determining direction.

(1) Using a Measuring Device. An observer can measure direction by using a compass or an instrument that has been oriented for direction, such as a MULE, BC scope, or aiming circle. (See paragraph 2106.)

(a) Lensatic or M2 Compass. The lensatic compass has an accuracy of only +/- 50 mils. The M2 compass must be declinated but provides readings to an accuracy of +/- 10 mils.

(b) Modular Universal Laser Equipment. The MULE has a north-finding module to determine direction to an accuracy of +/- 2 mils. Direction can then be read to the nearest mil. Advanced procedures can be used to orient the MULE for direction when the north-finding module is nonfunctional. A detailed discussion on the use of the MULE is contained in chapter 9.

(c) Battery Commander Scope. A BC scope, or aiming circle that has been oriented for direction, provides readings to one mil. The accuracy depends on the means of orientation.

(2) Measuring From a Reference Point. Direction can be determined by using a reference point with a known direction. By determining the angular deviation in mils between the reference point and the target, a direction can be computed by applying the deviation to the known direction. (See figure 2-2 on page 2-9.) Add the mils to the known direction if the target is to the right of the reference point; subtract if the target is to the left (right add, left subtract (RALS)). Angular deviation can be determined by using any instrument with a reticle pattern or by hand measurement. (See paragraph 2103.) It is measured to an accuracy of one mil when

using a reticle pattern (MULE/BC scope/aiming circle), five mils for handheld binoculars or AN/GVS-5, or 10 mils by hand.

(3) Scaling From a Map. The observer may scale direction from a map to an accuracy of 10 mils by using a protractor.

(4) Estimating. Estimating on the ground is the least accurate method, but it can be used when the observer requires speed or is separated from his map and compass. The observer should be able to visualize a cardinal/intercardinal direction, as depicted in figure 2-1, remembering that the sun and moon rise in the east and set in the west.

2103. Determining Angular Deviation. The observer must be able to determine angular deviation or measurement. In addition to using angular deviation or measurement to determine direction, he uses it for determining horizontal and vertical distances to target location and in determining corrections in adjustment. The observer can determine angular deviation or measurement by use of the following.

a. Reticle Patterns. Reticle patterns are found on optical instruments and are the primary means of measuring angular deviation. Binoculars and AN/GVS-5s can measure angular deviation to an accuracy of +/- 5 mils. MULEs, BC scopes, and aiming circles can all measure angular deviation to an accuracy of +/- 1 mil. Any object within the field of view with a known direction can serve as a reference point. Binoculars are the most common tool for measuring horizontal and vertical angles. (See

figure 2-2 and paragraph 2106.) When operating in a static situation, the observer can more accurately determine angular deviation by using the reticle pattern on a MULE, BC scope, or aiming circle. These instruments provide a stable platform and are extremely useful when accurate measurements are paramount, for example, for precision missions, for measuring vertical angles, and for night observation. When oriented, they provide accurate *direction*. When not oriented, the reticle pattern can still be used to measure angular deviation to an accuracy of +/- 1 mil.

b. Hand Measurement of Angles. The observer may use his hand and fingers for angular deviation or measurement in situations where speed is essential or when he has no other means. The observer fully extends his arm with the palm of his hand pointed toward the target area or reference point. By using the values contained in figure 2-3 on page 2-10, the observer can determine an approximate angular deviation or measurement. To increase his accuracy, the observer should determine the actual values of his hand and finger measurements. He does this by comparing a known deviation between two objects with that derived from his hand/fingers.

c. Measurement of Angles With Objects. The observer may also use common objects to measure angles as shown in figure 2-4 on page 2-10. Without more accurate means available and knowing the actual size of potential targets and the measurements shown in figure 2-4, the observer can quickly determine range with reasonable accuracy. (See figure 2-5 on page 2-11.)

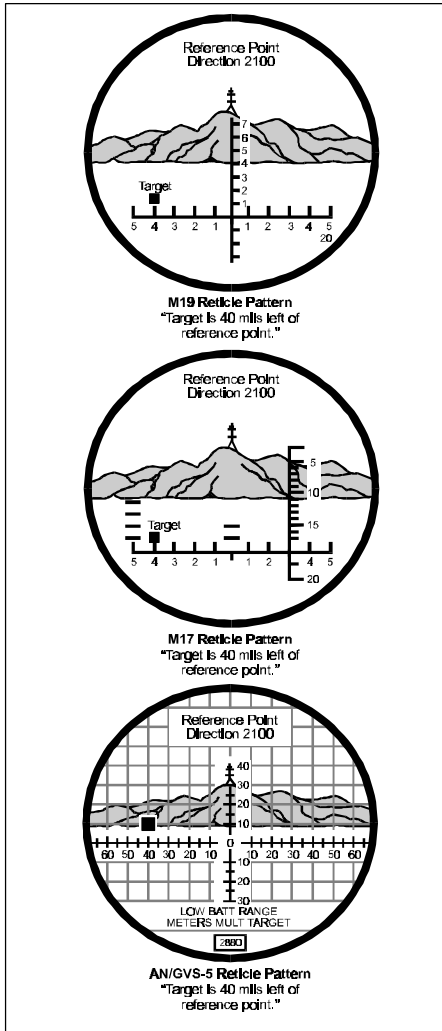

Figure 2-2. Measuring Angular Deviation.

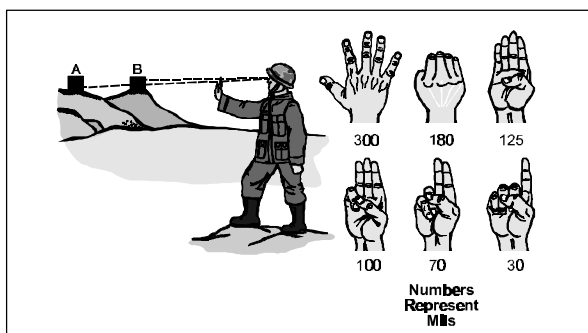

Figure 2-3. Hand Measurement of Angular Deviation.

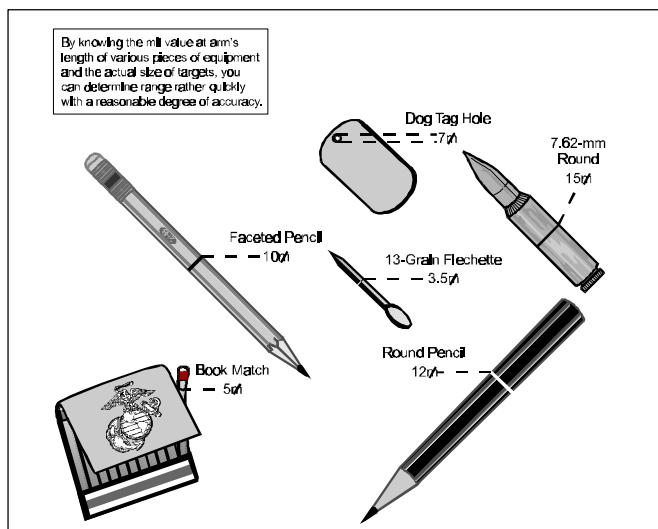

Figure 2-4. Angular Measurement of Common Objects.

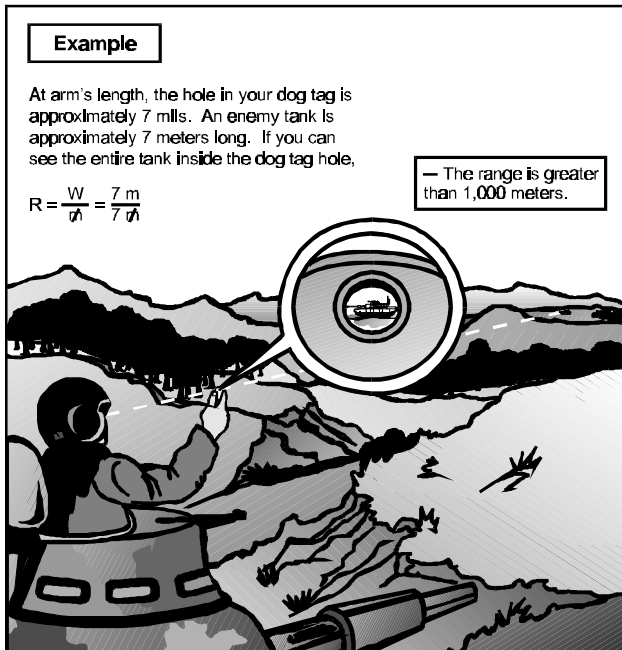

Figure 2-5. Determining Range With Common Objects.

2104. Distance. Distance is the second element of target location. Once the direction has been determined, the observer must determine distance to the target. Distance is the horizontal space between a reference point or a ground observer and a target. Distance is normally the most difficult variable to determine in target location. It is also used in adjustment of fire, for example, OT factor. (See chapter 3, section III.) The meter is the standard unit of measurement for distance. Other units of measurement may

be used if specified in the call for fire. Distance can be determined by one of the following methods.

a. By Measuring Distance (Laser Rangefinder). The MULE or the AN/GVS-5 provides the quickest, most accurate means of determining distance. When battery operated, its usage should be conserved. (See paragraph 9003.) The MULE and AN/GVS-5 measure distances to an accuracy of +/- 10 meters.

b. By Sound

(1) Sound Ranging: Flash-to-Bang Method. To determine distance by using the flash-to-bang method, count the number of seconds between a round detonation (flash) and the sound of the impact (bang), and multiply this time by the speed of sound (350 meters/second).

Formula

$$\text{Flash to bang (sec)} \times 350 = \text{distance (m)}$$

This method has several uses to the observer; for example, it allows the observer to confirm distances. By using the flash-to-bang distance to a round impacting in the battlespace, the observer can associate this distance on the ground with a future target. For example, if the flash-to-bang distance is 4,000 meters and the observer sees a target between himself and the previous point of impact used in the flash-to-bang method, he knows that the target must be closer than 4,000 meters. Similarly, the flash-to-bang method can be used to verify the OT factor during adjustment. The

method can also be used to determine the distance to the muzzle flash of an enemy weapon. When combined with a good direction, the observer can achieve accurate target location data.

(2) Audible Sounds. There will be occasions when the observer will not be able to see the flash of a weapon or a round detonation. To estimate distance in these situations, the observer can use common sounds. Table 2-1 provides frequently heard noises with estimated distances.

Table 2-1. Audibility of Various Actions.

Maximum Distance (m)	Sound
100 - 200	Human speech
300	Stakes being pounded into the ground by hand
500	Stakes being pounded into the ground mechanically
500 - 1,000	Trenches being dug (shovel striking rocks or iron)
800	Tree cutting, tree falling
1,000 - 2,000	Automatic fire
3,000	Single rifle shot

c. By Estimating Distance. The observer must estimate the distance if a more accurate method is not available. The degree of accuracy depends on several factors, such as terrain relief, time available, and experience of the observer. Generally, the longer the observer remains stationary, the better he can use this method.

(1) Mental Estimation. A mental distance estimate is made by use of a known unit of measurement. Distance is estimated to the nearest 100 meters by determining the number of known units of measurement between the observer's position and a target. For example, a football field, which is 100 yards long, can be used as a known unit of measurement for determining the distance between an observer's position and a target. For longer distances, it may be required to progressively estimate distance. To do this, the observer determines the number of units of measurement to an intermediate point and doubles the value. The observer should consider the effects in table 2-2 to estimate distances.

Table 2-2. Considerations in Mental Estimation of Distances.

Conditions in Which Objects Appear Nearer	Conditions in Which Objects Appear More Distant
In bright light	In poor light or in fog
In clear air at high altitude	When only a small part of the object can be seen
When the background is in contrast with the color of the object	When the background is similar in color to that of the object
When the observer is looking down from a height	When the observer is looking over a depression, most of which is visible
When the observer is looking over a depression, most of which is hidden	When the observer is kneeling or sitting, especially on a hot day, when the ground is moist
When the observer is looking down a straight feature such as a road	
When the observer is looking over water, snow, or a uniform surface such as a cultivated field or desert	

(2) Estimating When Visibility Is Good. When visibility is good, distances can be estimated by using the appearance of tree trunks, their branches, and foliage (as seen by the naked eye) in comparison with map data. Table 2-3 can be used as a guide for wooded terrain. Numerous other objects may be used to estimate distances as well. Table 2-4 on page 2-16 can be used as a guide for urban environments.

Table 2-3. Use of Trees and Foliage for Estimating Distance.

Distance (m)	Tree Description
1,000	Trunk and main branches are visible. Foliage appears in cluster-like shape. Daylight may be seen through the foliage.
2,000	Trunk is visible, main branches are distinguishable, foliage appears as smooth surface. Outlines of foliage of separate trees are distinguishable.
3,000	Lower half of trunk is visible. Branches blend with foliage. Foliage blends with adjoining trees.
4,000	Trunk and branches blend with foliage and appear as a continuous cluster, smooth in appearance. Movement of foliage caused by wind cannot be detected.
5,000 and beyond	The whole area covered by trees appears smooth and dark.

(3) Estimating by Using Known Dimensions. Distance can be estimated by using known dimensions of vehicles and the mil-relation formula ($W = R \times \text{mil}$). By using the width of a vehicle appearing perpendicular to an observer as the lateral distance (W)

and measuring the width in mils (m), the distance can be determined by solving the formula for range in thousands (R), or $R = W \div m$. This data, when compared with map data, will help an observer to estimate distances. Dimensions of equipment can be obtained from armored vehicle recognition cards (Graphic Training Aid (GTA) 17-2-13), which can be obtained from the battalion S-2 or supply officer. The dimensions of selected equipment are provided in table 2-5 on page 2-17.

Table 2-4. Use of Various Objects for Estimating Distance.

Distance (m)	Object Identified by the Unaided Eye
1,000	Lone tree trunk
1,500	Individuals and horsemen
3,000	Chimneys on rooftops
4,000	Windows in houses
4,000 - 5,000	Individual houses in a populated area
8,000 - 9,000	Villages and individual houses
15,000 - 18,000	Large houses, towers, and steeples

(4) Estimating From a Terrain Study. The observer should always use terrain/map analysis to assist in estimating distances. When the observer is looking in a specific direction, the estimation of distance can be enhanced by studying the terrain to associate what he is actually seeing on the ground with what he is seeing on the map. The use of an observed fire (OF) fan helps the observer to associate map and compass direction, maintain orientation for

direction, and refine distances. Particular emphasis should be given to color contrasts of terrain features seen along the OTL. For example, the distance across successive ridge lines or depressions in the distance may be identifiable by only slight changes of color to the eye. Different colors of grass might reveal a hidden terrain feature such as a stream.

Table 2-5. Example of Estimating Distance by Using Known Dimensions.

Equipment	Dimensions (m)	
	Side View	Front View
Tank (T-80) (chassis)	7.4	3.4
Tank (T-62) (chassis)	6.5	3.4
Reconnaissance vehicle (BRDM-2)	5.7	2.4
Reconnaissance vehicle (BTR-60)	7.5	2.8
Armored personnel carrier (BMP)	6.8	2.9
Air defense weapon (ZSU-23-4)	6.3	2.9

Example

An observer sees an armored personnel carrier (BMP). He measures its width as seen from a side view as two mils.

Formula

By using the formula, he determines the distance:

$$R = W \div m \text{ where:}$$

$$m = 2 \text{ mils (measured by binoculars)}$$

$$W = 6.8 \text{ m (known dimension of side view)}$$

$$R = 3,400 \text{ m } (6.8 \div 2 = 3.4)$$

2105. Altitude. The third element of target location is altitude. Altitude is “the vertical distance of a level, a point or an object considered as a point, measured from mean sea level.” (Joint Pub 1-02) The meter is the standard unit of measurement for altitude. There are three methods of measuring altitude:

- Map spot—if measured from a map spot, the altitude of a target is determined by use of contour lines and the contour interval of the map.
- Vertical shift—altitude may also be determined as a vertical shift from the altitude of the observer’s position or from a known point to the target. (The vertical shift, given as an up or down, uses the same principles of angular deviation and the mil relation formula discussed in paragraph 2103. The M2 compass clinometer can be used and is discussed in paragraph 2106.)

- Vertical angle—laser polar missions specify the vertical angle in mils. This allows the FDC to incorporate the vertical shift with the associated distance for accurate target location.

Example

“Altitude 480,” “up 50,” and “vertical angle three.”

2106. Tools To Assist the Observer. The following tools are used by the observer in target location and terrain and map analysis. These tools include the M2 compass, binoculars, BC scope, GPS, OF fan, terrain sketch, and visibility diagram. Chapter 9 discusses AN/GVS-5 and MULE employment. The tools are most effective when used together.

a. M2 Compass. The M2 compass is the most accurate compass for determining direction (+/- 10 mils). It is a multipurpose instrument used to obtain azimuth readings and vertical angles. The magnetic needle (the white end of the needle) shows a magnetic north. The magnetic needle reading is taken from the black end when the bubble is centered in the circular level. The azimuth scale adjuster assembly rotates the azimuth scale to introduce the declination constant.

(1) Declinating the M2 Compass. The procedure for declinating the M2 compass from a surveyed declination station free from magnetic attractions is as follows:

- Set the M2 compass on a tripod over the orienting station, and center the circular level.

- Sight on the known, surveyed azimuth marker.
- By using the azimuth adjuster scale, rotate the azimuth scale until it indicates the same as the known surveyed azimuth.
- Recheck sight picture and azimuth to the known point. Once the sight picture is correct and the azimuth reading is the same as the surveyed data, the M2 is declinated.

The procedure for field-expedient declination of the M2 compass is as follows:

- By using the azimuth adjuster scale, set off the grid-magnetic angle (shown on the bottom of all military maps).
- Once the grid-magnetic angle has been set off on the azimuth scale, the M2 compass is declinated.

Note

Once declinated, the M2 compass measures *grid azimuths*.

(2) Measuring Azimuths With the M2 Compass. The procedure for measuring an azimuth follows:

- To read the azimuth scale by reflection, hold the compass in both hands at eye level with arms braced against the body and with the rear sight nearest your eyes. Place the cover at an angle of approximately 45 degrees to the face of the compass so that the scale reflection can be viewed in the mirror. (See figure 2-6.)

- Level the instrument by viewing the circular level in the mirror.
- Sight on the desired object, and read the azimuth indicated on the reflected azimuth scale by the south-seeking (black) end of the compass needle.

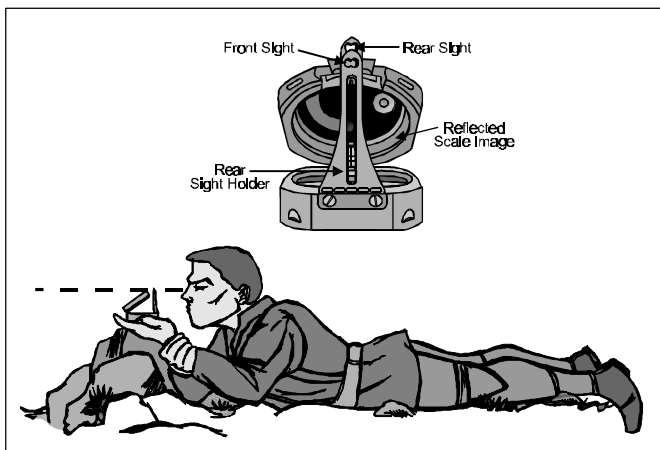

Figure 2-6. Measuring an Azimuth With the M2 Compass.

(3) Measuring Vertical Angles With the M2 Compass. The procedure to measure a vertical angle with the M2 compass is as follows:

- Hold the compass on edge with both hands at eye level with arms braced against the body and with the rear sight nearest your eyes.

- Place the cover at approximately 45 degrees to the face of the compass so that the elevation scale reflection can be seen in the mirror. (See figure 2-7 on page 2-23.)
- Sight on the target or crest, and center the elevation scale tubular level with the lever on the back of the compass and by viewing the elevation scale in the mirror.

Read the elevation in mils on the elevation scale. Measure again, and record the average.

Warning

The M2 compass must be employed free of magnetic attractions. Below are the minimum distances that should be kept when using the compass to measure a direction.

High-tension power lines: 55 m

Artillery, trucks, or tanks: 10 m

Telegraph, telephone, or barbed wire: 10 m

Crew-served weapons: 2 m

Rifle or radio: 0.5 m

b. Binoculars. In addition to measuring angular deviation, binoculars enable observers to focus on distant objects. When using binoculars, the following considerations apply:

- The binoculars must be held parallel to the deck and steadied against the body or a prop.
- The observer should determine, memorize, and record his interpupillary and depth settings to allow for quick adjustment.

- The protective plastic lens cap on the binoculars can be removed to increase the field of vision for observers who wear glasses.
- Masking tape can be used on the metal retaining ring to prevent scratching the glasses.

The diopter adjustment ring can be taped in the correct position so that the observer does not have to adjust the diopter setting every time he uses his binoculars.

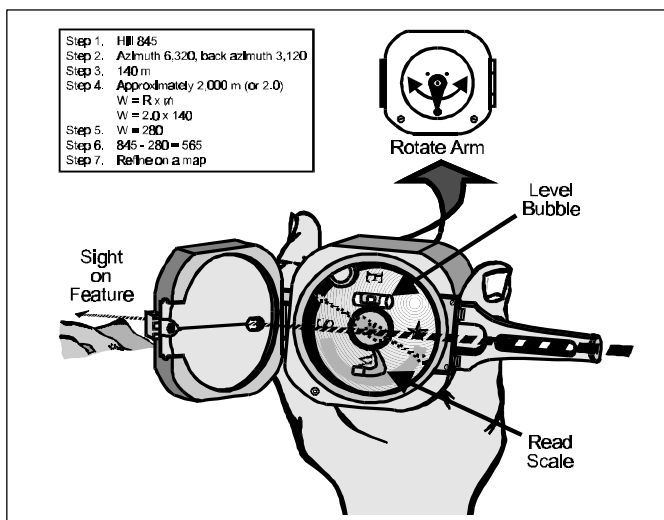

Figure 2-7. Measuring the Vertical Angle.

c. Battery Commander Scope and Aiming Circle. Both the BC scope and aiming circle provide a stable platform for observation. When oriented for direction, they can measure direction to an accuracy of +/- 1 mil (depending on the source of orientation). The aiming circle can provide its own

source of orientation with its magnetic needle. Emplacement of the BC scope is the same as for the aiming circle, which is referenced in MCWP 3-16.3/U.S. Army Field Manual (FM) 6-50, *Tactics, Techniques, and Procedures for the Field Artillery Cannon Battery*. The procedures for orienting for direction follow:

- Ensure that the instrument is leveled.
- Place the known azimuth on the upper (or recording) motion. (The scale should show the known azimuth.)
- With the lower (nonrecording) motion, sight on the known azimuth marker. (The scale should still show the known azimuth.)
- Use only the upper motion to measure direction.
- Do not move the lower motion unless reorienting.

d. Global Positioning System. The GPS is a space-based navigation system that provides worldwide, continuous, all-weather, three-dimensional position information. The GPS includes satellites and receivers. The current receiver is the AN/PSN-11 PLGR. The PLGR can provide the observer with grid location and navigational information. To use the PLGR, verify the following.

(1) Cryptographic Keys. The proper cryptographic keys must be loaded into the PLGR to enable it to use the precise positioning system (PPS). The PPS must be used to achieve the necessary

accuracy and to avoid enemy electronic warfare measures. If the cryptographic variable is not loaded, PLGR accuracy is lessened.

(2) Datum. The map datum should be the same as the operational datum being used by all other maneuver, fire support, and target acquisition units. If the same datum is not used, significant position errors are possible.

(3) Coordinates. The universal transverse mercator (UTM) coordinate format is preferred because it is the standard used by survey and most fire control systems.

(4) Elevation. Mean sea level is the preferred selection because most military maps use it as the basis for the elevation scale.

(5) Units of Measurement. Meters is the preferred selection because most military maps refer to distance and elevation in meters.

(6) Almanac Data. Almanac data must be one day old. If almanac data are not one day old, satellite vehicle or timing errors not noted by the PLGR are possible.

(7) Figure of Merit. Figure of merit (FOM) is an accuracy estimation of the data displayed by the PLGR; it ranges from one through nine. FOM 1 is the best accuracy estimation displayed by the system, and FOM 9 is the worst. For observer positioning, only coordinates determined with FOM 1 will be considered to be accurate.

(8) Mode of Operation. The PLGR offers three choices—fix, continuous, and averaging—as modes of operation. The averaging mode yields the most accurate data and is preferred when determining a position for indirect-fire weapon employment.

(9) Position. Position verification by a separate means to check for gross errors should always be performed.

Warning

Azimuth determined with the PLGR is for navigation only. The PLGR azimuth is not accurate enough for use in establishing directional control and should never be used for orienting observation devices. Tests show that PLGR-determined azimuth may be in error by as much as 200 mils. Refer to Technical Manual (TM) 11-5825-291-13, *Operations and Maintenance Manual for Satellite Signals Navigation Sets AN/PSN-11*, for further information.

The PLGR does not relieve the observer of his land navigation responsibilities. He must be able to locate both himself and targets without the aid of GPS for the following reasons:

- GPS receivers rely on electronic line of sight with the satellites. The PLGR must be able to acquire at least four satellites so that a three-dimensional position can be determined. Dense foliage, buildings, mountains, and canyons will mask the GPS signal and cause the receiver to fail.
- Multipath distortion (reflected signals) may occur if the receiver's antenna is tilted away from a satellite. This causes a

reflected signal to be received that has more power than the direct signal. Coordinates determined under these conditions can be off by as much as several hundred meters.

- Electronic warfare can jam GPS signals for periods of time.

e. Observed Fire Fan. The OF fan is a transparent protractor that can be used to refine distance on the map. (See figure 2-8 on page 2-28.) It is not used to determine direction. It helps the observer to identify on the map what he sees on the ground. The OF fan has 17 radial lines that are 100 mils apart and cover a total area of 1,600 mils. The radial lines represent OT direction. The OT distance is represented by arcs marked on the fan every 500 meters and labeled every 1,000 meters, beginning at 1,000 meters and extending to 6,500 meters.

Note

The OF fan is available in the supply system as GTA 6-7-3.

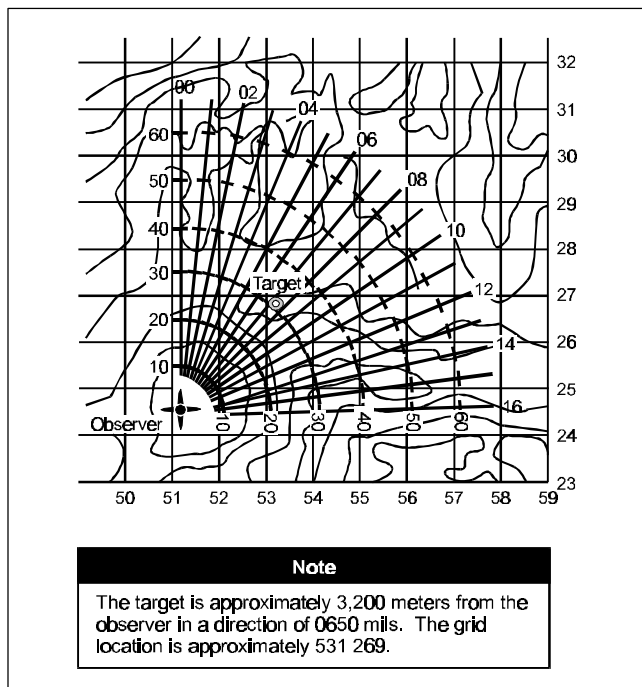

Figure 2-8. Target Location Using the Observed Fire Fan.

(1) Orienting the Observed Fire Fan on the Map. To prepare the OF fan, perform the following steps:

- Place the vertex of the OF fan over the observer's location.
- Place the center radial in the direction of the center of the observer's sector of observation.

- Move the fan slightly until one of the radial lines is parallel to a grid line. The direction of that radial line is the same as that of the grid line. For example, a radial line parallel to a north-south grid line, with the OF fan oriented generally north, would be direction 6400 or 0.
- Attach the OF fan in position on the map by using a piece of tape along one edge of the fan. The OF fan can then be lifted, when required, without disturbing its orientation.
- With a marker pen or grease pencil, number the radial of known direction, dropping the last two zeros (6400 would be 64). Then label every second radial with the appropriate direction. Remember that the radial lines are 100 mils apart. (Direction increases to the right and decreases to the left.)

(2) Using the Observed Fire Fan. To determine target location, the observer must first determine direction and distance by using a method discussed previously. Then he plots the data on the OF fan by finding a radial line corresponding to the OT direction. Visual interpolation is required if the direction plots between two radials. The observer follows the radial or interpolated radial until he has scaled off the estimated distance. He compares the terrain near the target with the terrain of his estimated point on the map. If they agree, his target location is accurate. If they do not agree, he searches along the radial line until he finds terrain that matches. The target *must* be along the radial or interpolated radial line representing the direction to the target. (See figure 2-8 for target location using the OF fan.) When the observer is rapidly changing positions, he can orient his fan over the next prominent terrain or

manmade feature that he will cross. He notes the direction to a known point or feature in the target area. In this manner, he can maintain the relative orientation of his OF fan to aid in determining direction and target location.

f. Terrain Sketch. The terrain sketch is a rough panoramic drawing by the observer of his area of observation. (See figure 2-9 on page 2-31.) The sketch is primarily used as a rapid means of recording/identifying predetermined directions to reference points. A properly constructed terrain sketch aids the observer in an organized study of the terrain. A terrain sketch also provides a rapid means of orienting relief personnel. The terrain sketch should include the following:

- The skyline (horizon)
- Prominent objects or features such as draws, hill masses, streams, wood lines, ridge line, roads, buildings, battlespace debris, and so on
- Directions and distances to prominent objects or features, with labeling of reference and known points.

g. Visibility Diagram. To locate targets and report battlespace information effectively, the observer must be able to see within his area of observation. However, as a result of terrain features, certain areas will not be visible from the observer's location. A visibility diagram will pinpoint those areas that cannot be seen by the observer. The visibility diagram is a sketch that is drawn to scale by the observer of the area of observation. (See figure 2-10 on page

2-32.) It shows those portions of the terrain that cannot be observed from a given OP.

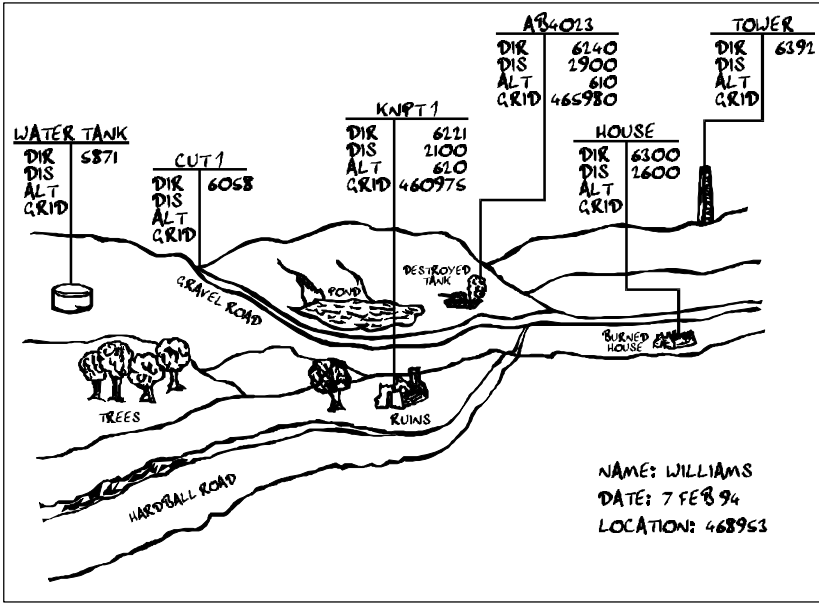

Figure 2-9. Terrain Sketch.

(1) **Construction of the Visibility Diagram.** The construction of the visibility diagram requires a detailed study of the terrain. (For steps in constructing the visibility diagram, see appendix E.) In fast-moving operations, there may not be time to construct a visibility diagram. In these cases, observers still need to locate areas that they cannot observe. A possible alternative would be a verbal report giving azimuths and distances to screening obstacles.

Another alternative would be to give a grid location and radius of an area that cannot be observed. However, at the first opportunity, the observer must construct a visibility diagram.

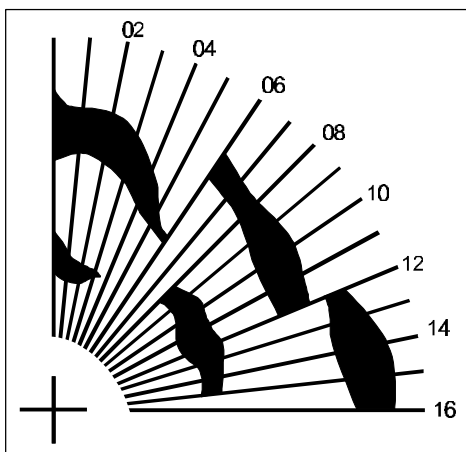

Figure 2-10. Visibility Diagram.

(2) Using the Visibility Diagram. The most important use of the visibility diagram is to help coordinate the complete visual coverage of the battlespace. Ideally, the visibility diagrams are reviewed by the company commander and dispatched to the infantry and artillery S-2 officers. The diagrams are used to evaluate target area coverage so that gaps can be covered. They also determine the best locations and orientations for other target acquisition resources. Visibility diagrams are used to reduce errors in reporting target locations. If a target plots in an area that is not visible, the target location is obviously in error.

h. Radar Beacon. The radar beacon is “a receiver-transmitter combination which sends out a coded signal when triggered by the proper type of pulse, enabling determination of range and bearing information by the interrogating station or aircraft.” (Joint Pub 1-02) The radar beacon is a lightweight portable radar transponder used to aid in the delivery of accurate NGF under all conditions of visibility. The beacon provides an electronic reference point ashore from which beacon-capable ships can fix their actual or relative location. Use of the beacon can practically eliminate the navigation error element from the initial salvo error. The types of beacons that are currently in inventory are the AN/UPN-32 and the AN/PPN-19. The AN/PPN-19 can also be used by aircraft. Currently, all U.S. Navy ships with five-inch guns are capable of acquiring a beacon. The beacon is normally emplaced by a small radar beacon team (usually two or three men), which may be attached to the battalion SFCP or to a reconnaissance unit. The beacon transmits 1 of 10 different electronic signals or codes; this signal or code is set in the field by the beacon team for acquisition by the ship. If the radar beacon is used, beacon data will be sent to ships via an operational message, general (maritime tactical message), amphibious (OPGEN MIKE) or via an operational tasking (maritime tactical message), amphibious (OPTASK AMPHIB) message. When notified by an SFCP that the radar beacon will be used for a mission, ship personnel will select the method to be used. After acquiring the correct signal transmitted by the beacon, ship personnel report to the SFCP “locked on and tracking beacon” and await the call for fire. Ship personnel may use the beacon in one of three methods.

(1) **Method ALFA.** This method may be used when the exact location of the beacon is known (OPORD or beacon team information). In this method, the beacon is used simply as a navigation aid to determine the ship's position. Fire missions are conducted in the normal manner discussed in subsequent chapters.

(2) **Method ALFA Modified.** This method may be used when the exact location of the beacon is not accurately known and when combat grid charts are not available. The observer gives target location in polar coordinates or as a shift from the beacon position. (See section II of this chapter for procedures for polar plot and shift from a known point.) Ship personnel plot the beacon location, the ship's relative position, and the target's position relative to the beacon. The target is the point of aim and is engaged as a simple indirect-fire mission.

(3) **Method BRAVO.** This method may be used whether or not beacon location is accurately known. The observer locates the target by using polar coordinates from the beacon position. The beacon location is the point of aim, and offsets are introduced into the computer to lay the gun on target. This method is normally the fastest but does present a potentially unsafe condition. In the event that the offsets do not register in the ship's gunfire control system, the beacon team position will become the point of aim.

Section II. Methods of Target Location

Terrain/map analysis is essential in target location. The results of this analysis (i.e., direction, distance, and altitude) provide the basic data for determining a target's location. Knowledge of information in section I of this chapter is essential to accomplishing the various methods of target location. Because the methods of target location apply to the artillery/mortar FO and the NGF spotter, the word *observer* is applicable to both except where separately addressed. The observer selects a method of target location based on whether his position is known by the firing unit, the availability of known/reference points in the battlespace, and tools available for target location. Three methods of target location exist: polar plot, grid coordinates, and shift from a known point.

Note

Regardless of the method of target location, map datum information is a prerequisite to accuracy. The firing unit must know the spheroid or datum (e.g., World Geodetic System 1984) and grid zone from the marginal information on the observer's map before conducting missions.

2201. Polar Plot. In the polar plot method, the observer describes the target location in relation to his position. The primary advantage of the polar plot method is that it is fast and can be done without a map. Laser rangefinders and oriented BC scopes greatly enhance the accuracy of the polar plot. The primary disadvantage of this method is the chance that the enemy may determine the observer's position by intercepting the call for fire and computing a

back azimuth from the target. Another disadvantage is that the observer's position must be known by the firing unit (battery, mortar platoon, or ship). This may require the observer to transmit his location and altitude before sending the call for fire. Figure 2-11 shows target location by the polar plot method.

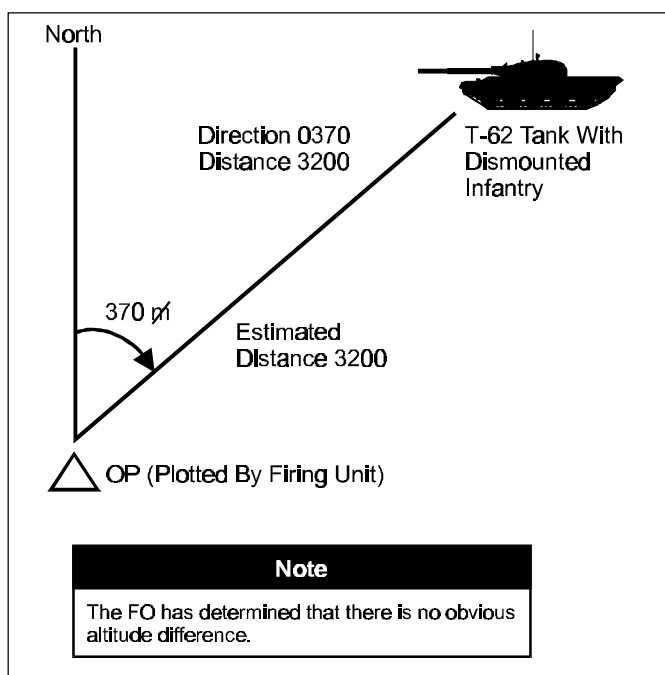

Figure 2-11. Polar Plot Method of Target Location.

a. Steps for Determining Data. The steps to determine polar plot data are listed below.

(1) Determine the OT direction to the nearest 10 mils. An oriented BC scope will determine direction to the nearest mil.

(2) Determine or estimate the distance to the target to the nearest 100 meters. Laser data will be determined to the nearest 10 meters. Distance will be transmitted in the call for fire as “distance” followed by the distance to the target (meters understood).

(3) Determine the vertical difference between the observer and the target. The vertical difference will be transmitted in the call for fire as an “up” or “down” shift from the altitude of the observer to the altitude of the target if the shift is 35 meters or more. Any vertical shift that is determined will be transmitted to the nearest 5 meters (or 20 feet). The vertical shift increases the accuracy of the target location and should always be given if possible.

Note

When employing an instrument that provides greater accuracy than the minimum requirements, it is acceptable to determine and transmit the more accurate data.

b. Laser Polar. A MULE that has been oriented for direction provides the quickest, most accurate means of target location. If the firing unit has met its requirements for accurate fire, the mission type for laser polar missions should be fire for effect. If not, one round in adjustment is adequate. Not only do laser polar missions provide a more accurate target location; the subsequent corrections are processed differently from regular missions as well. Target location is determined by the FDC by using vertical angle to the

nearest mil and incorporating distance as the slant range. An oriented BC scope or aiming circle used with a laser rangefinder can also be used to provide accurate laser polar data. Laser polar data determines direction to the nearest mil, distance to the nearest 10 meters, and vertical angle (versus shift) to the nearest +/- 1 mil.

2202. Grid Coordinates. The observer can locate a target by using the grid system of the military map. If the observer has conducted a thorough terrain/map study, the grid coordinate method of target location is recommended. There is no requirement for the observer's position to be known by the firing unit. The observer normally locates targets to an accuracy of 100 meters (six-place coordinates). When additional accuracy is required (e.g., known points), the observer should locate targets to the nearest 10 meters (eight-place coordinates).

a. Artillery and Mortars. The grid method of target location is transmitted in the call for fire as "grid" followed by the coordinates. OT direction can be transmitted after the call for fire has been sent (ideally when reading back the message to observer (MTO)), but it must be transmitted before or with the first adjustment.

Example

"Grid 452 677."

b. Naval Gunfire. The grid method of target location is transmitted in the call for fire as "grid" followed by the coordinates and "altitude" followed by the altitude of the target measured from sea level to the nearest 5 meters (or 20 feet). Direction is also

transmitted in the target location element if the method of control is spotter adjust.

Example

“Grid 452 677, altitude 65, direction 0830.”

or

“Grid 452 677, altitude 65, direction GTL.”

2203. Shift From a Known Point. In shift from a known point, the observer locates the target in relation to a known point. Target location by shifting from a known point offers several advantages—it is accurate, it does not require the use of a map, and the observer’s location is not required to be known by the firing unit. However, the firing unit must know the location and altitude of the known point. The known point may be a terrain reference point that was previously reported or a target that was previously fired on and recorded. For NGF, it may also be a radar beacon position. The steps in locating a target by a shift from a known point are as follows.

a. Step One. Identify the known point to be used.

(1) Artillery and Mortars. The known point is transmitted in the *warning order* element of the call for fire by using the words “shift known point (or target number) _____.”

(2) Naval Gunfire. The known point is transmitted in the *target location* element of the call for fire by using the words “from reference point (or target number) _____.”

b. Step Two. Determine the OT direction to the nearest 10 mils.

c. Step Three. Determine the lateral distance between the known point and the target to the nearest 10 meters. This is a two-step process. First, the observer determines the angular deviation in mils between the two. Then, by using the mil-relation formula, the observer multiplies the angular deviation (m) by the range to the known point (R) to the nearest 100 meters expressed in thousands (called the shift factor) to determine the lateral shift (W) in meters. (See figure 2-12 on page 2-41.) The lateral shift will be transmitted in the call for fire as a “left” or “right” (meters are understood). The shift factor is used to determine only the initial lateral shift. The OT factor is used for all subsequent corrections. (See paragraph 3302.)

Example

“Right 110.”

Note

If the angular deviation is greater than 600 mils, use of the shift from a known point should be avoided because the mil-relation formula becomes

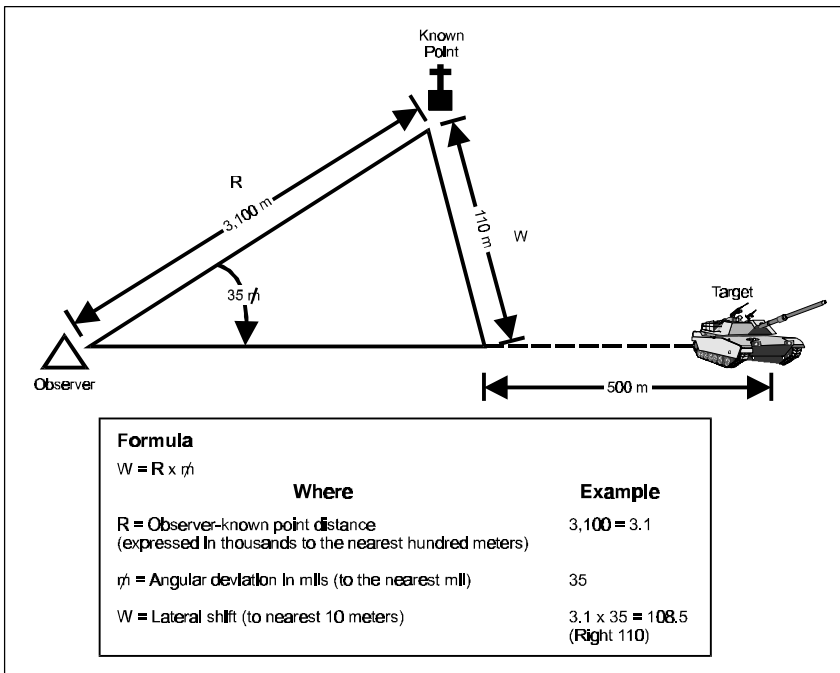

Figure 2-12. Mil-Relation Formula in Shift From a Known Point.

d. Step Four. Determine the range shift in meters between the known point and the target to the nearest 100 meters. The range shift will be transmitted in the call for fire as an “add” if the target is farther away from the observer than the known point or as a “drop” if the target is closer. Meters are understood and need not be specified.

Example

“Add 500.”

e. Step Five. Determine the vertical difference between the known point and the target. The vertical difference will be transmitted in the call for fire as an up or down shift from the altitude of the known point to the altitude of the target. Only vertical shifts of 35 meters or greater will be transmitted. In addition, any vertical shift that is transmitted will be expressed to the nearest 5 meters (or 20 feet), if possible.

Example

“Up 35.”

2204. Locating Targets in Mobile Operations. An observer with a motorized or mechanized unit (e.g., mounted in trucks, assault amphibian vehicles, or tanks) must be extremely proficient in his duties, particularly map reading and terrain association.

a. Preparations. The success of the observer depends largely on his preparations before the operation begins. These preparations include the following:

- Become acquainted with the vehicle. The observer should learn his position on the vehicle and the position of other team members. He should ensure that the position assigned will allow him to accomplish his mission; for example, it should allow him

to observe, communicate, and coordinate with other supporting arms representatives.

- Ensure that required equipment/information is placed in an accessible location for quick reference, for example, maps, targets, radio, and frequencies.
- Study the map. The observer should study the map to the extent that he can mentally picture what he expects to see, for example, prominent landmarks. He should identify points or features along the planned route from which he can readily determine his orientation.

b. Considerations. The observer has to consider certain factors when conducting target location in mobile operations. The most important factors are direction, selection of method of target location, and actions should the observer become disoriented.

(1) Direction. As a result of the observer's movement, it will be necessary to change OT direction frequently. Another factor to consider is the magnetic effect of the vehicle on the compass. The observer will have to move 10 meters away from the vehicle to avoid interference or use another method of determining direction, for example, scaling from a map, estimating, or using the GTL. (See paragraph 2102.)

(2) Selection of Target Location Method. The grid method is the fastest and most accurate method for mobile operations if the observer has made a detailed map/terrain analysis. The observer can call for fire on planned targets or use these targets to shift to a

target of opportunity. The accuracy of the shift will largely depend on the accuracy of the OT direction. The polar plot method is of limited use in mobile operations unless the observer has short static periods and constantly updates his position. Using GPS in these situations makes polar plotting feasible.

(3) Actions Should the Observer Become Disoriented. As a result of the tactical situation, the observer may have difficulty maintaining adequate observation and orientation. This may make it difficult to locate his own position and the target's location. In these situations, the observer can call for fire on a planned target and shift from the burst location. If the observer is completely disoriented, he can call for "mark center of sector." (See paragraph 3104.) If there is doubt about the safety of the firing, a high air burst (e.g., 200 meters) with shell high explosives (HE) or white phosphorus (WP) can be used. The tactical soundness of the high air burst must be considered. Knowledge of the tactical situation and disposition of friendly forces by the firing unit will prevent a friendly unit from being fired on.

Chapter 3

Requesting and Adjusting Artillery, Mortars, and

Naval Gunfire

Section I. Artillery and Mortar Call for Fire

3101. Elements of the Call for Fire. The call for fire is “a request for fire containing data necessary for obtaining the required fire on a target.” (Joint Pub 1-02) It is a concise message prepared by the observer and transmitted as a request, not an order. It contains the information needed by the FDC to determine the method of target attack. The call for fire is sent quickly but clearly enough to be understood, recorded, and read back without error by the FDC recorder. In the FO team, the initial elements of the call for fire should be sent by the radio operator while the FO determines the remaining data, for example, target location. The radio operator completes the call for fire as data becomes available. Regardless of the method of target location used, the normal call for fire is transmitted in three parts consisting of six elements with a break and readback after each part. The parts and elements are as follows:

- Observer identification and warning order
- Target location
- Target description, method of engagement, and method of fire and control.

3102. Observer Identification and Warning Order

a. Observer Identification. The first element of the call for fire, observer identification, lets the FDC know who is calling for fire and clears the net for the fire mission. The observer uses a call sign and a suffix. Once given, call signs are omitted from subsequent transmissions during the mission unless there is a chance of confusion, for example, when missions are being conducted simultaneously by other observers. (See figure 3-1 on page 3-3.)

b. Warning Order. The second element, warning order, is “a preliminary notice of an order or action which is to follow.” (Joint Pub 1-02) The warning order consists of the type of mission, the size of the element to fire for effect, and the identification of the method of target location. (See figure 3-1.)

(1) Type of Mission. The observer selects a type of mission. The type of mission can be adjust fire, fire for effect, suppression, immediate suppression/smoke, or suppression of enemy air defenses (SEAD). The suppression and immediate suppression missions are discussed in paragraph 3105. Immediate smoke is discussed in paragraph 5705. SEAD is discussed in chapter 8. The *adjust-fire mission* is requested when the observer decides that an adjustment is needed because of questionable target location or lack of registration corrections. For this mission, the observer announces “adjust fire” in the warning order. The *fire-for-effect mission* is used when the observer has an accurate target location and is certain that the first volley will have an effect on the target. For this mission, the observer announces “fire for effect” in the warning

order. The accuracy required to fire for effect depends on the target and the ammunition being used. The observer should strive for first-round fire for effect.

Situation 1	
(Grid Method of Target Location)	
Observer:	“R2S this is W2P31, adjust fire, over.”
FDC:	“P31 this is R2S, adjust fire, out.”
Situation 2	
(Polar Plot Method of Target Location)	
Observer:	“R2S this is W2P31, adjust fire, polar, over.”
FDC:	(FDC reads back.)
Situation 3	
(Shift From a Known Point Method of Target Location)	
Observer:	“R2S this is W2P31, fire for effect, shift AB 1037, over.”
FDC:	(FDC reads back.)
Note: The observer used the fire-for-effect type of mission in situation 3 because he had a good target location.	

Figure 3-1. Examples of Observer Identification and Warning Order.

(2) Size of Element To Fire for Effect. The observer may request the size of the unit to fire for effect, for example, a battalion. This is usually done by announcing the last letter in the battalion FDC’s call sign. For example, T6H24 will be announced “H.” The observer should never refer to a unit in the clear. If the observer does not specify a size of element to fire for effect, the FDC will

make the decision based on the attack guidance received and the *Joint Munitions Effectiveness Manual (JMEM)* solution. Mortars may be employed by platoon or section, which must be specified.

(3) Method of Target Location. The observer identifies in the warning order the method that he will use to locate the target. The method of target location may be polar, grid, or shift from a known point. (See chapter 2.) If the observer is using either the polar or shift method, he announces the method, for example, “polar” or “shift (identify known point).” If the observer is conducting a laser polar plot, he should announce “laser polar.” This will facilitate fire direction. There is no requirement to announce “grid” in the warning order for the grid method of target location.

3103. Target Location. The third element of the call for fire is target location. The observer provides the FDC with the target location data that he determined by using either the grid, polar, or shift method. The firing unit uses the data to determine firing data. (See figure 3-2 on page 3-5.) The observer transmits the target location data as described below.

a. Grid. The observer announces the word “grid” followed by the coordinates of the target.

b. Polar. The observer announces the word “direction” followed by the spotting line (e.g., 1680), “distance” followed by the distance from the observer to the target (meters understood), and, if possible, an “up” or “down” vertical shift.

Situation 1
(Continued from Figure 3-1)
(Grid Method of Target Location)

Observer: "Grid 347 689, over."

FDC: "Grid 347 689, out."

Situation 2
(Continued from Figure 3-1)
(Polar Plot Method of Target Location)

Observer: "Direction 1680, distance 3500, down 35, over."

FDC: (FDC reads back.)

Situation 3
(Continued from Figure 3-1)
(Shift From a Known Point Method of Target Location)

Observer: "Direction 0680, right 250, add 200, over."

FDC: (FDC reads back.)

Figure 3-2. Examples of Target Location.

c. Shift From a Known Point. The observer announces the word "direction" followed by the spotting line, the lateral shift (if any) transmitted as "left" or "right," the range shift (if any) transmitted as "add" or "drop," and, if applicable, an "up" or "down" vertical shift. Laser polar missions always announce vertical angle.

3104. Target Description, Method of Engagement, and Method of Fire and Control

a. Target Description. The fourth element of the call for fire, target description, is the element in which the observer describes the target in enough detail to enable the FDC to determine the amount and type of ammunition to be used. The observer's description should be brief but accurate and contain the following:

- What the target is (troops, supply dump, trucks)
- What the target is doing (digging in, in assembly area)
- The number of elements in the target (squad, three trucks)
- The degree of protection (in the open, in fighting holes, in bunkers with overhead protection)
- Target size and shape, if these are significant.

(1) Rectangular Targets. Rectangular targets are greater than 200 meters in length and width. They are described by the length and width of the target and the attitude (the azimuth of the long axis (0000-3200) in relation to grid north) to the nearest 100 mils.

Example

"400 by 200, attitude 2800."

(2) Circular Targets. Circular targets are for irregular-shaped targets with a radius greater than 100 meters. They are described by using the radius of the target area.

Example
"Radius 200."

(3) Linear Targets. Linear targets are targets greater than 200 meters long but less than or equal to 200 meters wide. They are described by an attitude and a length.

Example
"Length 400, attitude 1300."

(4) Irregular-Shaped Targets. Irregular-shaped targets are described by using the location of the target center, the length and depth (in meters), and, if required, the attitude. Sufficient detail should be provided to enable the FDC to determine the method of attack.

b. Method of Engagement. The fifth element of the call for fire, method of engagement, is the element that the observer uses to describe the attack of the target. The subelements of the method of engagement include the type of adjustment, mark, danger close, trajectory, ammunition, and distribution. Some of the subelements are standard and will be provided automatically unless the observer specifies otherwise. The standard type of adjustment is area fire; the standard trajectory is low angle for artillery (high angle for mortars); the standard ammunition is shell HE/fuze quick (HE/Q); the standard distribution is a circular sheaf for artillery (parallel sheaf for mortars). Nonstandard subelements must be addressed in the call for fire when required, for example, danger close if the

target is near a friendly position. The subelements of the method of engagement are transmitted (as required) in the following sequence.

(1) Type of Adjustment. Two types of adjustment may be employed—precision or area fire. Unless precision fire is specified, area fire will be used. *Precision fire* is conducted with one weapon on a point target. It is used either to obtain registration corrections or to destroy a target. When the mission is a registration, it is initiated by the FDC with an MTO. (See chapter 5, sections II and III). If the target is to be destroyed, the observer announces “destruction.” *Area fire* is used to attack an area target. Because many area targets can move, the adjustment should be made as rapidly and as accurately as possible to keep the target from escaping. A well-defined point should be selected at or near the center of the area to be attacked and used as an adjusting point. To achieve surprise, fire should be adjusted on an auxiliary adjusting point. After adjustment is completed, the fire for effect is shifted to the target. Normally, adjustment on an area target is conducted with one adjusting weapon.

(2) Danger Close. “Danger close” is included in the method of engagement when the predicted impact of a round or shell is within 600 meters of friendly troops for mortars and artillery. When alerted that the target is danger close, the FDC will take added precaution in the delivery of fires. The observer will use the creeping method of adjustment. (See paragraph 3302.e.) Omission of this subelement indicates that the target is away from a friendly position by at least the distances stated above. Minimum safe

distances provide a 99-percent assurance that a casualty-producing hit on friendly troops will not occur. (See appendix A.)

(3) Mark. The term “mark” is included in the method of engagement to indicate that the observer is going to call for rounds either to orient himself in his zone of observation or to indicate targets to ground troops, aircraft, or other observers. This term is included in the method of engagement only when needed.

Example

“Mark center of sector.”

(4) Trajectory. There are two types of trajectory—low-angle fire and high-angle fire. For *artillery*, low-angle fire is standard and need not be specified. If high-angle fire is desired, it must be specified. For more information on high-angle fire, see chapter 5, section I.

Example

“High angle.”

For *mortars*, high-angle fire is standard and need not be specified.

(5) Ammunition. Several types of ammunition are available to the observer. The standard type of ammunition is HE/Q. If HE ammunition is specified in the call for fire, HE/Q will be fired in the adjustment and fire-for-effect phases. The term “in effect” indicates that the projectile/fuze specified is desired during fire for effect.

Nonstandard types of ammunition are specified in the call for fire. The observer must state either a projectile or a fuze, for example, “shell ICM” (projectile) and “VT in effect” (fuze). Illumination, ICM, and smoke can only be fuzed with fuze time. Therefore, when firing these projectiles, fuze time is understood and need not be specified. See appendix A for a discussion of projectiles and fuzes.

(6) Volume of Fire. The observer may request the number of rounds to be fired in effect. For example, “three rounds” indicates that the firing unit fires three volleys during the fire for effect. This equates to 18 rounds fired by a six-howitzer battery. If not requested, the volume of fire is determined by the fire direction officer (FDO) and announced in the MTO.

(7) Distribution. In *artillery*, the observer may control the pattern of bursts in the target area. The pattern of bursts is called a sheaf. The sheaf denotes the lateral distribution of bursts of two or more pieces fired together. Special sheafs of any length and width may be requested. When target length and width are given, attitude must also be given. When target length is equal to or greater than five times the target width, the battery computer system (BCS) assumes a linear target. Figure 3-3 on page 3-11 depicts the various sheafs. In *mortars*, the mortar ballistic computer (MBC) assumes that the target is linear and fires a parallel sheaf unless a special sheaf is requested.

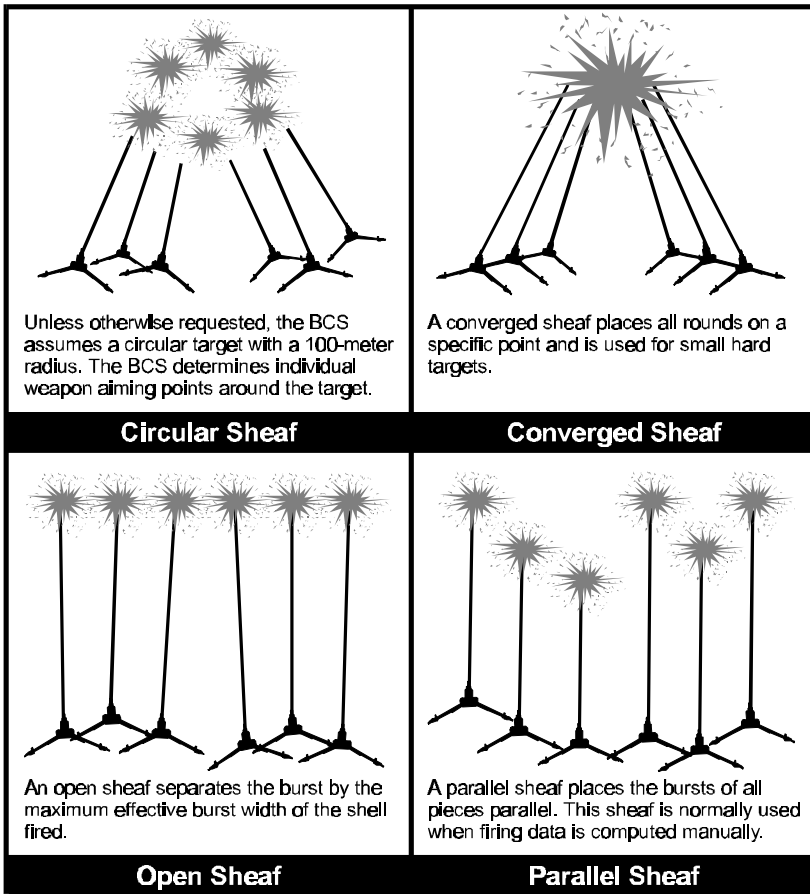

Figure 3-3. Sheafs.

c. Method of Fire and Control. The sixth element of the call for fire, method of fire and control, indicates the desired manner of attacking the target, whether or not the observer wants to control

the time of delivery of fire, and whether or not he can observe the target. (See figure 3-4 on page 3-13.) Methods of fire and control are announced by the observer as discussed below.

(1) Method of Fire. In area fire, adjustment is normally conducted with one howitzer or with the center gun of a mortar platoon or section. Adjusting at long ranges, however, may sometimes be easier with two howitzers or guns firing. If the observer determines that a two-howitzer/gun adjustment is more appropriate for the mission, he may specify “two guns adjust” for artillery or “section adjust” for mortars. If, either for adjustment or effect, the observer wants the firing unit to fire by pieces from right to left or left to right, he specifies the unit and indicates right by piece (for left to right) or left by piece (for right to left), for example, “battery right by piece.” The normal time interval between rounds fired in a platoon or battery right (left) is five seconds. The observer may specify a different time interval if desired.

(2) Method of Control. In the absence of a specified method of control, fire missions are executed by the firing unit when ready.

(a) At My Command. If the observer wants to control the time of delivery of fire, he announces “at my command” in the method of control. When the pieces are ready to fire, the FDC announces “section/platoon/battery/battalion is ready, over” (call signs are used). The observer announces “fire” when he is ready for the pieces to fire. This only applies to adjusting rounds and the first volley of a fire for effect. At my command remains in effect during

the mission until the observer announces “cancel at my command, over.”

<p style="text-align: center;">Situation 1 (Continued from Figure 3-1) (Grid Method of Target Location)</p> <p>(Observer desires to adjust with HE/Q then fire for effect with WP.)</p> <p>Observer: “Five trucks refueling in the open, WP in effect, over.”</p> <p>FDC: (FDC reads back.)</p> <p style="text-align: center;">Situation 2 (Continued from Figure 3-1) (Polar Plot Method of Target Location)</p> <p>(The target is danger close. Observer desires HE/Q or to let the FDC select the projectile/fuze.)</p> <p>Observer: “Infantry platoon in the open, danger close, over.”</p> <p>FDC: (FDC reads back.)</p> <p style="text-align: center;">Situation 3 (Continued from Figure 3-1) (Shift From a Known Point Method of Target Location)</p> <p>(The observer selects a sheaf to concentrate the fires on a specific point and desires to control the timing of the fires.)</p> <p>Observer: “Machine gun position, converged sheaf, at my command, over.”</p> <p>FDC: (FDC reads back.)</p>
--

Figure 3-4. Examples of Target Description, Method of Engagement, and Method of Fire and Control.

(b) By Round At My Command. At my command can be further specified. By round at my command controls every round in adjustment and every volley in the fire-for-effect phase. By piece,

by round, at my command, further combines method of fire with method of control and can include right or left or a duration.

(c) Do Not Load. Do not load allows the howitzer/gun section to prepare ammunition and lay on the target without loading the howitzer. When the command “cancel do not load” is transmitted, the section automatically loads and fires the weapon (except for an at my command mission). Do not load is the recommended method of control for long wait or uncertain missions.

(d) Cannot Observe. Cannot observe indicates that the observer cannot see the target. This may be because of vegetation, terrain, weather, or smoke. Cannot observe is used when there is a reason to believe that a target exists at a given location and the target is important enough to justify firing without adjustment.

(e) Time on Target. Time on target (TOT) is a method of firing on a target in which a unit times its fire so that the initial round strikes the target at the time specified. The observer indicates TOT by using one of the techniques discussed in appendix D.

(f) Continuous Illumination. Continuous illumination is a type of fire in which illumination projectiles are fired at specified time intervals to provide uninterrupted lighting on the target or specified area. The interval may be specified by the observer (in seconds) or determined by the FDC. If no interval is given by the observer, the FDC determines the interval by the burning time of the illumination ammunition in use. Continuous illumination must be used with discretion to avoid excessive ammunition expenditure.

(g) Coordinated Illumination. Coordinated illumination is a type of fire in which the firing of illuminating and HE projectiles is coordinated to provide illumination of the target and surrounding area only at the time required for spotting and adjusting fire. The observer may allow the FDC to control the firing of the illumination and HE rounds by marking the illumination round when it provides optimal illumination on the target, or he may control the firing of each round by using procedures of by round at my command. (See paragraph 5604.)

(h) Cease Loading. The command “cease loading” is used during the firing of two or more rounds to stop the loading of rounds into the gun(s). The gun section may fire any rounds that have already been loaded.

(i) Check Firing. The command “check firing” is used to cause an immediate halt in firing. Once check firing has been announced, the command “cancel check firing” must be given to resume firing.

(j) Continuous Fire. Continuous fire means loading and firing as rapidly and as accurately as possible within the prescribed rate of fire for the equipment. Firing will continue until suspended by the command “cease loading” or “check firing.”

(k) Repeat. During adjustment, “repeat” means to fire another round by using the same firing data used to fire the previous round and adjust for any change in ammunition. Repeat is not sent in the initial call for fire.

Example

“Time, repeat, over.”

During fire for effect, “repeat” means to fire the same number of rounds using the same method of fire for effect. Changes in the number of guns, previous corrections, interval, or ammunition may be requested.

3105. Call for Fire for Suppressive Fire. Suppressive fires are “fires on or about a weapons system to degrade its performance below the level needed to fulfill its mission objectives, during the conduct of the fire mission.” (Joint Pub 1-02) *Suppressive fires are delivered as a suppression mission or as an immediate suppression mission.* A suppression mission is used to fire on a planned target that is *not currently active*. An *immediate suppression mission is used to fire on a planned target or target of opportunity that has taken friendly maneuver or aerial units under fire.* Both the suppression and immediate suppression missions yield suppressive results only during the time when the fire is being delivered. Firing on a planned target is more responsive than firing on a target of opportunity. It is important that the maneuver unit *does something* while the suppressive fires are making impact, for example, maneuver against the target, position the observer to adjust fire to neutralize the target, or bypass the target.

a. Suppression Mission. The call for fire consists of the observer identification, the warning order “suppress,” the target number of

the planned target, and the duration and rate of fire. This call for fire is sent in one transmission.

Example

Observer: "R2S this is W2P31, suppress AB 3104, four minutes, four shells per minute, over."

FDC: "P31 this is R2S, suppress AB 3104, four minutes, four shells per minute, authenticate DELTA JULIETT, over."

Observer: "I authenticate DELTA, out."

b. Immediate Suppression Mission. An immediate suppression mission normally requires a minimum volume of fire. The type of ammunition, units to fire, and volume are established by unit SOP, for example, two sections, one round of HE/point detonating (PD), one round of HE/fuze variable time (VT). The call for fire is sent in one transmission. The call for fire consists of the observer identification, the warning order "immediate suppression," the target location, and transmission authentication. (See paragraph 3108.)

Example

Observer: "This is W2P31, immediate suppression, grid 221 432, authentication is TANGO UNIFORM, over."

FDC: "This is R2S, immediate suppression, grid 221 432, out."

3106. Direction. In *artillery* and *mortars*, direction is not included in the initial call for fire when the grid method of target location is used. When conducting a grid mission, the observer transmits the direction when reading back the MTO or with the first subsequent correction in adjustment.

3107. Message to Observer. After receiving the call for fire, the FDO determines how the target will be attacked. That decision is announced to the observer in the form of an MTO, which the observer reads back. The MTO should be sent to the observer before the first subsequent correction. At a minimum, the MTO will consist of unit(s) to fire, any changes to the call for fire, number of rounds, and target number. The FDC will provide other information, as required.

Note

An MTO is not transmitted for an immediate suppression mission.

a. Units to Fire. Units to fire refers to the batteries or battalion that will fire the mission. If the battalion is firing for effect with one battery adjusting, the FDC designates the fire-for-effect unit (battalion) and then the adjusting unit (ALFA battery) by using the last letter of the call sign.

Example

ALFA battery (R6G) will adjust, and the battalion (A8T) will fire for effect.
The MTO would begin "T, G . . ."

b. Changes to the Call for Fire. Any changes to the observer's request in the call for fire are announced.

Example

The observer requested ICM in effect, and the FDO decides to fire VT in effect. The MTO would be "T, G, VT in effect . . ."

c. Number of Rounds. This is the number of rounds per tube in fire for effect.

d. Target Number. A target number is assigned at the FDC to each mission to facilitate processing of subsequent corrections.

Example

"T, G, VT in effect, four rounds, target AA 7732, over."

e. Other Information as Required

(1) Probable Error in Range. Probable error in range (PE_R) is the distance in meters over and short of a given point of aim within which 50 percent of all rounds fired are likely to fall. (See figure 3-5 on page 3-21.) For example, for an M198 howitzer firing HE at a range of 6,000 meters (charge 5-GB), one PE_R is nine meters. There is a 50-percent chance that any given round will impact nine meters over or short of the point of aim when fired at this range. The remaining rounds will impact within four PE_R or 36 meters over or short of the target (as depicted by the box in figure 3-5). By

contrast, one PE_R for the same weapon firing at a range of 14,000 meters is 20 meters. PE_R varies with several factors, for example, range, propelling charge, ammunition, and weapon. The FDC normally selects the optimal firing data to minimize PE_R . However, circumstances (e.g., intervening crests, counterfire threat) may require the selection of a less than optimal gunnery solution. The FDC reports the PE_R when it is excessive to prevent the observer from attempting to correct the impact of a round caused by natural dispersion, for example, when the PE_R is equal to or greater than 38 meters during an area fire mission and 25 meters or greater in a precision fire mission such as registrations or destruction.

(2) Angle T. Angle T is the angle formed by the intersection of the OTL and the GTL with the vertex of the angle at the target location. Angle T is sent to the observer when it is greater than or equal to 500 mils, or when requested. See figure 3-10 on page 3-53 for the effect of angle T on the adjustment of fire.

(3) Time of Flight. Time of flight (TOF) is the time in seconds from the instant when a weapon is fired to the instant when the round strikes or detonates. TOF is sent to an observer when adjusting high-angle fire, during a moving-target mission, for Copperhead missions, when firing for an aerial observer, for shell HE in a coordinated illumination mission, when using “by shell at my command,” or when requested.

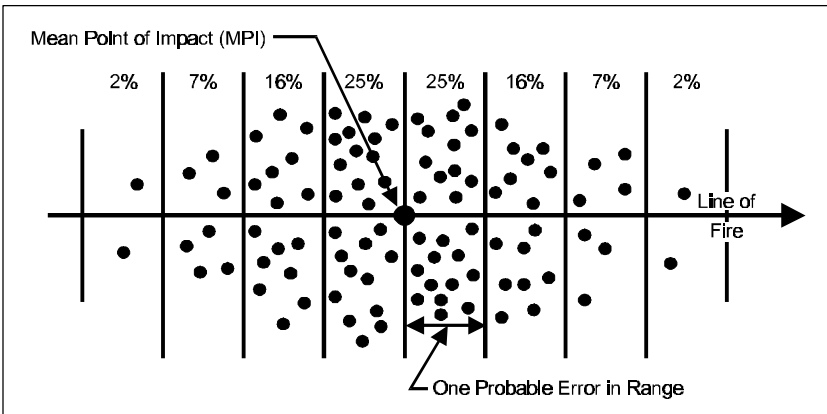

Figure 3-5. Probable Error in Range.

Note

The MTO for registrations is discussed in chapter 5.

3108. Authentication. The two methods of authentication that are authorized for use are challenge-and-reply and transmission authentication. For instructions on authentication procedures, refer to the automated communications-electronics operating instructions (CEOI).

a. Challenge-and-Reply Authentication. Challenge-and-reply authentication is considered to be a normal element of initial requests for fire. The FDC inserts the challenge in the last readback of the fire request. The FO transmits the correct authentication reply to the FDC immediately following the challenge.

Authentication replies exceeding 20 seconds are automatically suspect and a basis for rechallenge. Subsequent adjustment of fire or immediate engagement of additional targets by the observer originating the initial fire request normally will not require continued challenge by the FDC.

b. Transmission Authentication. Transmission authentication will be used only if authentication is required and it is not possible or desirable for the receiving station to reply, for example, message instruction, imposed radio silence, FPF, and immediate suppression.

Example

(Challenge and Reply)

FDC: "Authenticate ALFA, BRAVO, over."

Observer: "I authenticate CHARLIE, out."

Example

(Transmission Authentication)

Observer: "Authentication is TANGO UNIFORM, out."

3109. Report Upon Firing

a. Shot. The firing unit will transmit "shot" after each round fired in adjustment and after the initial round in the fire-for-effect phase. The observer acknowledges each.

Example

FDC: "Shot, over."

FO: "Shot, out."

b. Splash. When requested, the transmission of "splash" by the FDC informs the observer when his round is five seconds from detonation. Firing units should automatically report "splash" during high-angle firing, when the observer is airborne, and for other missions when requested by the observer. When reported, "splash" should be transmitted for each round in adjustment and for the initial round in each volley of fire for effect. In coordinated illumination missions, "splash" is reported for illumination rounds fired before the beginning of the HE adjustment phase of the mission and only for HE rounds thereafter. When in the assault, "splash" allows the supported unit to close with their fires. It allows the observer to remain under cover and concealment while awaiting the fires, thus enhancing his survivability. This transmission also helps the observer to identify or observe his rounds if other fire missions are being conducted in the area. The observer is not required to acknowledge the transmission.

Example

FDC: "Splash, out."

3110. Correction of Errors. Errors are sometimes made by the observer in transmitting data or by the FDC personnel in reading back the data. If the observer realizes that an error has been made,

he announces “correction” and transmits the entire corrected transmission.

Example

The observer transmitted, “A1B this is C2D, adjust fire, shift known point two, over, direction 4680 . . .” The observer realizes before proceeding that the direction should have been 5680. To correct the error, he transmits, “Correction, direction 5680.”

When an error has been made in a subelement and the correction of that subelement will affect other transmitted data, the word “correction” is announced. Then the correct subelement and all affected data are transmitted in the proper sequence.

Example

The observer transmitted, “Left 200, add 400, up 40, over.”
(The correction should have been “Left 200, drop 400, up 40.”)
To correct the error, he transmits, “Correction, left 200, drop 400, up 40, over.”

3111. Call for Fire From Headquarters Higher Than Battalion.

Calls for fire from higher headquarters are similar in format to those transmitted by observers. The call for fire from higher headquarters may specify the unit to fire for effect. However, the observer’s call for fire can only request a firing unit. A call for fire from a higher headquarters is shown in the following example.

Example

Warning order: "Fire for effect, A8B (battalion), over."

Target location: "Grid 432 789, altitude 520, over."

Method of engagement: "VT, three rounds."

Method of control: "TOT 1600, over."

Section II. Naval Gunfire Call for Fire

3201. Fire Unit Status. A ship is assigned a fire support area (FSA) or a fire support station (FSS) from which to fire. When a ship arrives in its assigned firing position and has completed its preferring tasks, it will report "on station and ready to fire" as a part of the guns up ready to fire (GURF) report. The GURF report may include other pertinent information, for example, types and quantities of ammunition available for NGF support. The GURF report may be requested at other times by the NGLO or the spotter.

3202. Elements of the Call for Fire. The spotter must communicate effectively with the ship to perform his primary duty of providing NGF. The spotter achieves this by employing a standard call for fire. The call for fire is transmitted to the ship in two transmissions consisting of six elements, with a readback after each transmission. The sequence of these two transmissions is as follows: spotter identification, warning order and target number, target location, target description, method of engagement, and method of control.

3203. Spotter Identification, Warning Order, and Target Number

a. Spotter Identification. The spotter identification tells the ship who is calling for fire. The spotter and the ship will use call signs. Once given, call signs will normally be omitted from subsequent transmissions in the course of the mission. (See figure 3-6 on page 3-27.)

b. Warning Order. The warning order informs the ship that a call for fire is being transmitted. It clears the net and warns the ship that firing on a target is desired. The warning order consists of the words “fire mission.” (See figure 3-6.)

c. Target Number. The spotter assigns a target number to each target on which he calls for fire. By use of a target number, the ship and the NGLO monitoring the mission are able to keep track of each location being fired on. The target number consists of two letters followed by four numbers. For targets of opportunity, the spotter assigns each fire mission a number in numerical sequence from the block of target numbers allocated by the FSCC, or the FSCC may assign the target number. In the case of planned targets, the spotter uses the previously assigned target number. The assignment of target numbers to fire missions in the call for fire does not cause the targets to be recorded as targets. (See paragraph 3303.)

Situation 1

Spotter: “A1B, this is C2D, fire mission, target number AB 2135, over.”

Ship: “C2D, this is A1B, fire mission, target number AB 2135, out.”

Figure 3-6. Example of Spotter Identification, Warning Order, and Target Number.

3204. Target Location, Target Description, Method of Engagement, and Method of Control

a. Target Location. Target location provides the ship with the information needed to plot the target and determine firing data. (See chapter 2, section II.) The observer transmits target location data as described below.

(1) Grid. The spotter announces “grid” followed by the coordinates of the target; “altitude” followed by the altitude of the target, which is measured from mean sea level (meters understood); and “direction” followed by the spotting line if the method of control is spotter adjust.

(2) Polar. The spotter announces “direction” followed by the spotting line (e.g., 1680), “distance” followed by the distance from the spotter to the target (meters understood), and an up or down vertical shift.

(3) Shift From a Known Point. The spotter announces “from reference point” (or target number), “direction” followed by the spotting line, the lateral shift (if any) transmitted as a left or right, the range shift (if any) transmitted as an add or drop, and an up or down vertical shift.

b. Target Description. Target description gives a brief description of the target. The spotter considers the type of target, size, and degree of protection when formulating target description.

(1) Type of Target. Type of target includes what the target is and what the target is doing, for example, troops digging in or trucks in convoy.

(2) Size. Size includes the number of elements in the target or physical dimensions (meters understood). For target attitude, mils grid is understood.

Example

“Five trucks, 100 troops, 400 x 400 attitude 1600.”

(3) Degree of Protection. Degree of protection indicates whether the target has protection, for example, in the open or in bunkers with overhead cover.

c. Method of Engagement. Method of engagement is the element that the spotter uses to describe the attack of the target. The subelements of the method of engagement include danger close, trajectory, ammunition, armament, number of guns, number of salvos, and special instructions. Some of the subelements are standard and will be provided automatically unless the spotter specifies otherwise. The standard method of engagement for trajectory uses a full charge, which produces a high muzzle velocity and a normal trajectory. The standard method of engagement for

ammunition is HE/Q; for armament, it is main; for number of guns, it is one gun; and for number of salvos, it is one salvo. Nonstandard subelements must be addressed in the call for fire when required. An example is when the observer specifies danger close when the target is (and, therefore, the round will impact) near a friendly position. The subelements of the method of engagement are transmitted (as required) in the following sequence.

(1) Danger Close. The term “danger close” is included in the method of engagement when there are friendly troops or positions within a prescribed distance of the target. Danger close for unobserved or initial salvos of NGF projectiles that are smaller than 6 inches is 750 meters.

(a) The spotter reports “danger close” followed by a cardinal or intercardinal direction (based on grid north) and distance (in meters) from the *target* to the nearest friendly position. The spotter also designates the place where the first salvo (round) is to impact. The first salvo can be either *offset* or *directed at target*.

(b) The first salvo may be offset to impact on the side of the target opposite the location of the friendly forces or a restricted target, for example, class E. See MCWP 3-31.1/NWP 3-09.11, *Supporting Arms in Amphibious Operations*. This is done by a normal correction (left/right, add/drop) made in relation to the spotting direction or as a cardinal/intercardinal direction and distance (in meters). The offset between the nearest friendly position and the first salvo can be any distance specified by the spotter but is normally at least 750 meters for five-inch NGF.

Example

"Danger close south 350." (South 350 indicates friendly position in relation to target.) "First salvo at north 400." (The correction north 400 positions the offset at least 750 meters from the friendly position (350 meters + 400 meters = 750 meters).) The first salvo may be *directed at the target* when the tactical situation does not permit an offset. An example is "first salvo at

(2) Trajectory. This subelement applies to ships that are capable of reduced-charge or high-angle firing. The normal trajectory is flat and fired at full-charge propellant. The normal trajectory is standard; if this subelement is omitted in the call for fire, the ship will fire full charge. The spotter or ship may specify a nonstandard trajectory when required. The nonstandard trajectories are reduced charge and high angle.

(a) Reduced Charge. This is required when intervening terrain prevents engagement of targets in defilade. The spotter or ship raises the trajectory to increase the angle of fall by announcing "reduced charge." In addition, reduced charge lowers the initial velocity of the projectile. This prevents the ripping of illumination parachutes and increases the accuracy at short ranges. Once reduced charge has been initiated, it can be terminated by the command "cancel reduced charge."

(b) High Angle. High angle is fired with a full charge. It is used to engage targets in defilade when extended range or other considerations prevent the use of reduced charge. The spotter or

the ship announces “high angle.” Once initiated, it can be terminated by the command “cancel high angle.”

(3) Ammunition. Several types of ammunition are available to the spotter. The standard type of ammunition is HE/Q (PD).

(a) If no ammunition is specified in the call for fire, HE/Q will be fired in the adjustment and fire-for-effect phases. The term “in effect” indicates that the projectile/fuze specified is desired during the fire for effect.

(b) Nonstandard types of ammunition are specified in the call for fire. The spotter must state either a projectile or a fuze, for example, “shell WP” (projectile) or “fuze CVT” (fuze). When firing illumination, the fuze is understood to be fuze time and need not be specified.

(c) As much warning as possible should be provided to the ship when a mission requires a nonstandard projectile. This allows time to ready the ammunition in the gun mount. The quantities of nonstandard ammunition carried in the ship’s magazine are limited. See appendix A for a discussion of projectiles and fuzes.

(4) Number of Guns. The spotter may specify the number of guns to be used in adjustment and fire for effect. If the number of guns for effect is not specified, it is understood to be the same number as used in adjustment. One gun is considered to be the standard and need not be specified. If more than one gun is desired, the number of guns must be specified, for example, “two guns.”

(5) Number of Salvos. The term “salvo” refers to the method of fire in which a weapon, or number of weapons, is fired at a target. It indicates the number of projectiles to be fired from each gun.

Example

Five salvos equals five projectiles to be fired, while two guns five salvos would be 10 projectiles fired.

Number of salvos is sent when entering fire for effect or when the spotter desires to adjust with multiple salvos. If the method of control is spotter adjust, the number of salvos is omitted until the spotter is ready to enter fire for effect. If omitted, the ship will fire one salvo.

Example

“Two salvos in adjustment.”

(6) Special Instructions. The spotter uses special instructions in the call for fire when he desires the use of specific, nonstandard techniques to attack the target.

(a) Interval. Interval is a special instruction that is used to cause fire-for-effect rounds to be fired with a specific time interval between each salvo. The spotter announces “interval” followed by a desired time interval (seconds understood).

Example

“10 salvos, interval 30, fire for effect.”

(b) Sustained Fire. The sustained fire command is given if there is a requirement for fire for effect to be spread over a specific period of time. The spotter specifies “sustained fire.” The command includes the number of salvos and the period of time in which they are required to be fired.

Example

“20 salvos, sustained fire, five minutes, fire for effect.”

(c) Time on Target. TOT is used by the spotter when he wants the initial salvos in fire for effect to impact the target at a specified time. He may use any of the techniques described in appendix D.

(d) Coordinated Illumination. The coordinated illumination command is used by the spotter to inform the ship that, subsequent to adjusting illumination, the spotter will request simultaneous HE fire. He does this by announcing “coordinated illumination.”

(e) Continuous Illumination. The continuous illumination command is used when the spotter requires constant light on a target. The spotter may specify a period of time during which the illumination is to be effective. The ship determines the interval for firing the subsequent illumination salvos on the basis of the burning time of the projectile. The spotter commands “continuous

illumination.” This command should be used with discretion to avoid excessive expenditure of ammunition.

d. Method of Control. Method of control indicates the spotter’s desire or ability to control the delivery of fire. The standard method of control is spotter adjust and is omitted in the call for fire. The nonstandard methods of control are fire for effect and ship adjust. Fire for effect can be modified by the command “cannot observe.” All methods of control can be modified by the command “at my command.”

(1) Spotter Adjust. When there is doubt about target location or firing accuracy, the spotter will adjust salvos until he is sure that fire will impact the target. This method is understood to be standard and is omitted from the call for fire. The spotter may state this when he desires to revert to adjustment during a mission.

(2) Fire for Effect. The spotter should strive for fire for effect with the first round or as soon as possible in the adjustment phase. When determining whether or not to fire for effect on the first round, the spotter must consider the target location and how accurately the ship has been firing its initial rounds on previous missions. He must also consider the dispersion pattern of NGF. If the spotter believes that the first salvo will affect the target, the best results are normally achieved by surprise fire. When fire for effect is desired, the spotter specifies the number of salvos (and number of guns if different from that used in adjustment) and “fire for effect.”

Example

“10 salvos, fire for effect.”

“Fire for effect” can be modified by the command “cannot observe” when the spotter desires to fire on a suspected target or a target provided by intelligence sources. “Cannot observe” is used when neither the spotter nor the ship can see the target. The spotter must specify the number of salvos to be fired in the method of engagement.

Example

“Two guns, four salvos, cannot observe, fire for effect.”

(3) Ship Adjust. This method of control is employed when the spotter believes that the ship has a better view of the target than he does. Because direct fire is faster and more accurate, this method is used whenever possible. After the spotter has positively identified the target to the ship, he announces “ship adjust.” The ship then takes the target under fire. The spotter may assist the ship by providing range spottings along the GTL, particularly when he is looking perpendicular to the GTL.

(4) At My Command. At my command is used as a modifier to the three methods of control. At my command may be used when the spotter wants to control the precise firing of each salvo in spotter adjust and the first salvo of fire for effect. He includes “at my command” in the method of control. When the ship is prepared to fire each round, the ship will transmit “ready over.” The spotter

then commands “fire” when he is ready for the ship to fire the round. At my command remains in effect throughout the mission or until the spotter announces “cancel at my command.” At my command is frequently used by aerial observers. (See figure 3-7 on page 3-37.)

e. Prefiring Report. After the ship receives the call for fire and determines firing data, a report will be made to the spotter before firing begins. The spotter reads back this transmission to the ship and commands “break . . . fire, over.” The transmission consists of the following information.

Example

“Fire for effect, at my command.”

(1) Gun-Target Line. The ship will report its firing direction by using the same north reference and units used by the spotter. The ship will notify the spotter of subsequent changes to the GTL of 200 mils (10 degrees) or more. If the direction used for adjustment is the GTL, the ship will use mils grid in the call for fire if the direction in the call for fire was a cardinal/intercardinal direction, a GTL, or an arbitrary reference feature or if direction was omitted.

Situation 1

(Continued from Figure 3-6)

(Grid Method of Target Location, Spotter Adjust Mission)

Spotter: “Grid 786 543, altitude 05, direction 2680, 50 troops in open, fuze CVT in effect, over.”

Ship: (Ship reads back.)

Situation 2

(Continued from Figure 3-6)

(Polar Plot Method of Target Location, At My Command Mission)

Spotter: "Direction 2680, distance 3000, down 40, 50 troops in open, fuze CVT in effect, at my command, over."

Ship: (Ship reads back.)

Situation 3

(Continued from Figure 3-6)

(Shift From a Known Point Method of Target Location, At My Command Mission)

Spotter: "From target number AB 3772, direction 3470, left 280, add 500, supply depot in defilade, radius 200, reduced charge, two guns 10 salvos, fire for effect, at my command, over."

Ship: (Ship reads back.)

Figure 3-7. Examples of Target Location, Target Description, Method of Engagement, and Method of Control.

(2) Line of Fire. If the ship is firing illumination, the firing direction may not pass over the target because of wind drift of the flare parachute. To indicate the illumination projectile trajectory, the ship will report "line of fire" followed by the directional reference. The line of fire may be different from the GTL.

(3) Ready/Time of Flight. When the ship is prepared to fire the first salvo, the ship reports "ready" followed by the TOF (seconds understood). The spotter reads back the entire prefiring report and commands "break . . . fire." If the method of control included at my command, the ship will also report "ready" before firing each subsequent round. The ship will inform the spotter when there is a TOF change of more than five seconds.

Example

Ship: "GTL 1680, ready 17, over."

Spotter: "GTL 1680, ready 17, break . . . fire, over."

(4) First Salvo at (Point of Aim). When the spotter has reported a danger close situation, the ship confirms the point of aim that was previously ordered by the spotter.

Example

"First salvo at north 400."

(5) Summit. If the spotter is airborne, the ship routinely reports the highest altitude above mean sea level that the projectile will reach on its flight path to the target. Summit may also be requested by ground spotters or the NGLO. Summit is reported in feet to aerial observers and in meters to ground units.

(6) Any Changes. If the ship must change any portion of the spotter's fire request, the ship notifies the spotter of the change. For instance, if the spotter requests "WP in effect" and the ship has none remaining, the ship will announce "cannot comply with WP, HE in effect."

f. Authentication. To avoid deception, the ship should initiate authentication procedures on establishing initial communications with the spotter.

3205. Report Upon Firing. The ship will transmit “shot” and “splash” after each salvo is fired in adjustment and after the initial salvo in the fire-for-effect phase. There is no requirement for the spotter to acknowledge these transmissions.

a. Shot. Shot is transmitted at the moment the guns are fired.

b. Splash. Splash is transmitted five seconds before the round is expected to detonate. Splash is not reported during fire for effect when two or more ships are conducting a massed-fire mission. In coordinated illumination missions, splash is reported for illumination (star) shells before the beginning of the HE adjustment phase and thereafter for the HE round only.

Example

“Shot . . . splash, out.”

3206. Correction of Errors. Errors are sometimes made by the spotter or by the ship when transmitting data. The following procedures should be used to correct the data.

a. Correction. If the spotter realizes that he has made an error in his transmission, he immediately transmits the word “correction” followed by the corrected data. If the correction affects other subelements, his correction includes a restatement of the entire data.

Example

“Correction, direction 0670, over.”

b. Wrong. If an error is made during a readback, the word “wrong” followed by the correct data is transmitted at the end of the transmission. The word “wrong” is then read back, along with the corrected version.

Example

“Wrong, direction 0670, right 300, add 400, up 15, over.”

Section III. Adjustment of Fire

This section explains the procedures and the conditions for adjustment of fire. After a round bursts, a spotting is made and a correction is transmitted to adjust the fires onto the target. On satisfactory adjustment, the observer enters the fire-for-effect phase. This section is applicable to the artillery FO, the mortar FO, and the NGF spotter. Except where addressed separately, the word *observer* in the text refers to all three.

3301. Spottings. A spotting is an observer’s mental determination of the location of the burst or mean point of impact (MPI) of multiple bursts in relation to the adjusting point as observed along the OTL. Spottings are not normally announced except in situations involving straddle NGF and observed/lost spottings. Spottings must be made the instant that the burst occurs, except where delayed

deliberately to take advantage of drifting smoke or dust. The observer should position his binoculars for spotting before the burst appears. The observer holds the binoculars just below eye level, looking over the top of them with the naked eye until the burst is sighted. Then, the binoculars are raised to eye level and the spotting is made. Spottings are made for *height of burst* (HOB) to determine how high a burst is above the target, for *range* to determine how far a burst is beyond or short of the target, and for *deviation* to determine how far a burst is to the right or left of the OTL. The observer should consider spotting in that order (HOB, range, deviation) to determine the most difficult spottings first.

a. Height-of-Burst Spottings. HOB spottings are used to determine any increase or decrease required in the HOB or altitude of impact of a round. HOB spottings are used for adjusting air bursts when firing fuze time. These spottings are also used for making adjustments to ground bursts when attacking a target on a steep slope or with a vertical face. HOB spottings for air bursts are made to the nearest mil by using binoculars. HOB spottings are categorized as either air, graze, or mixed. These spottings are then used to make HOB corrections.

(1) Air. An air spotting is a round or group of rounds that burst in the air. The observer measures the number of mils above the target at which the air burst detonates. The spotting is made as *air* (so many mils) above the target.

Example
"Air 12."

(2) Graze. A graze spotting is a round or group of rounds that detonates or impacts. The spotting is made as *graze*.

(3) Mixed, Mixed Air, and Mixed Graze. A *mixed* spotting is a group of rounds that results in an equal number of air bursts and graze bursts. A *mixed air* spotting is a group of rounds that results in air bursts and graze bursts when most of the bursts are air bursts. A *mixed graze* spotting is a group of rounds that results in air bursts and graze bursts when most of the bursts are graze bursts. When attacking a target on a steep slope or with a vertical face, HOB spottings for *ground bursts* are the difference between the altitude (in meters) of the burst and the altitude of the target. The observer determines the difference by visual estimation or by map measurements. These spottings are then used to make HOB corrections.

b. Range Spottings. Definite range spottings are required to make a proper range adjustment. A graphical portrayal of range spottings is shown in figure 3-8 on page 3-43. Normally, a burst on or near the OTL provides a definite spotting. An observer can make a definite range spotting when the burst is not on or near the OTL by using his knowledge of the terrain, drifting smoke, and shadows. However, even experienced observers must use caution and good judgment when making such spottings. Possible range spottings are over, short, target, range correct, and doubtful.

(1) **Over.** An over spotting is a round that detonates beyond the target or adjusting point.

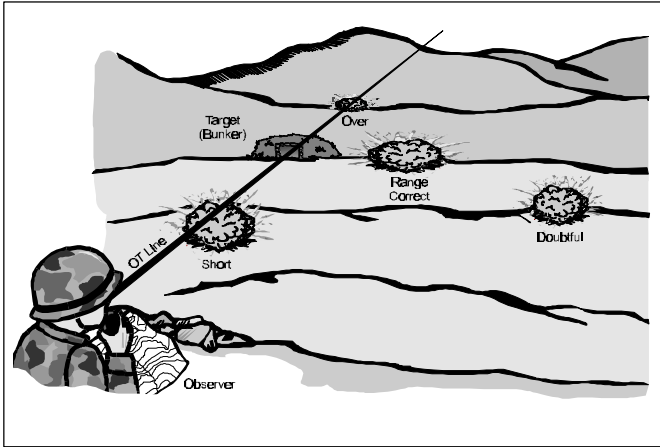

Figure 3-8. Range Spottings.

(2) **Short.** A short spotting is a round that detonates between the observer and the target or adjusting point.

(3) **Target.** A target spotting is a round that detonates on the target. This spotting is used in precision fire (artillery or mortar registration or destruction missions).

(4) **Range Correct.** A range correct spotting is a round that impacts at the correct range.

(5) Doubtful. A doubtful spotting is a round that is so far to the right or left of the OTL that a definite range spotting cannot be made.

c. Straddle (Naval Gunfire). In NGF, a spotting of *straddle* is made for a multigun salvo when some rounds fall short and some fall beyond the target. The spotter announces “straddle” followed by a correction to place the MPI on the target. The term is normally used during a ship adjust or a massed-fire mission.

d. Deviation Spottings. Deviation spottings determine the angular amount and direction of the deviation as seen from the observer’s position. Examples of deviation spottings are shown in figure 3-9 on page 3-45. During a fire mission, the observer measures deviation to the nearest five mils (nearest mil for precision fire) by using the method discussed in paragraph 2103. Possible deviation spottings are line or (so many mils) right or left of the OTL.

e. Unobserved Spottings. Under certain conditions, the observer may be able to make a spotting even though he is unable to see the round impact. For instance, he may hear but not see the round impact. By knowing the terrain, the observer determines that the only place that the round could have impacted without being seen is in a draw beyond the target. Although this is an *unobserved* spotting, the observer can make adjustments from the location where he determines that the round impacted.

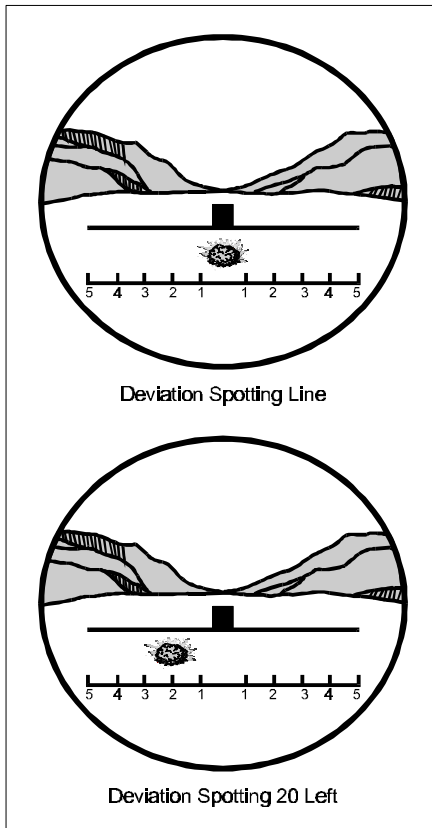

Figure 3-9. Examples of Computing Deviation Spottings.

1) Visibility Impairment. Visibility may be temporarily impaired in situations in which the observer has to take cover from incoming fire or smoke or dirt obstructs the target area visibility. The observer may also be unable to make an accurate spotting because

he cannot determine which round among several is his round. In any of these situations, he announces “repeat” to indicate his desire for another round to be fired with the same data.

(2) Lost Rounds. If the observer is unable to locate the round (either visually or by sound), the spotting is *lost*. This spotting is announced followed by the appropriate corrective action. Rounds may be lost for several reasons, including fuze malfunctioning (dud), terrain or weather that prevents the observer from spotting the round, or errors by the firing unit. When a round is lost, positive action must be taken. In selecting the course of action, the observer should consider his own experience, the firing unit’s proficiency as demonstrated on previous missions, and the location of the friendly elements with respect to the target. Corrective actions by the observer may consist of one or more of the following:

- Begin with a data check of the target location data and the call for fire.
- Request that the firing unit check their data. In NGF, the spotter would announce “check solution.”
- Request “repeat.”
- Request shell WP, a 200-meter air burst with HE, or a smoke round (artillery only) for the next adjustment.
- Make a bold shift. Ensure that friendly troops are not endangered.

If the above corrective action fails, send “end of mission,” and transmit a new call for fire. See paragraph 3303. for procedures on end of mission.

3302. Corrections. After spotting the burst, the observer determines and transmits a correction (in meters) to move the next round to be fired onto the target or adjusting point. Corrections are sent in the reverse order of the spotting (deviation, range, and HOB). The observer simultaneously corrects for deviation, range, and HOB as required.

a. Sequence of Subsequent Corrections. After the initial burst appears, the observer transmits subsequent corrections until the mission is terminated. These corrections include appropriate changes in elements that were previously transmitted and the necessary corrections for deviation, range, and HOB. Table 3-1 provides a means for the observer to organize his transmission of multiple corrections in an orderly flow. Of the possible corrections in table 3-1 on page 3-49, the observer uses only those correction that are required.

b. Direction. Direction is the key element for adjustment of rounds. Direction precedes all other subsequent corrections when announced. In *NGF*, direction is sent as part of the call for fire. In *artillery/mortars*, if direction is not included in the call for fire, it can be sent immediately after the call for fire, while reading back the MTO, or with the first subsequent correction. Refinement of or changes to direction are made when the original direction changes

by 100 mils/five degrees or more. Elements that may require correcting and the sequence of these corrections follow.

c. Deviation Corrections. Deviation corrections are determined in the following manner.

(1) Step One. Determine deviation spotting to the nearest five mils (one mil for precision fire).

(2) Step Two. Determine the OT factor. When the distance is greater than 1,000 meters, the OT distance is determined to the nearest 1,000 meters. The distance is then expressed in thousands (drop the last two digits) as the OT factor. If the OT distance is less than 1,000 meters, then the distance is determined to the nearest 100 meters and expressed in thousands.

(3) Step Three. Multiply the deviation spotting by the OT factor. Express to the nearest 10 meters. Deviation corrections are transmitted in multiples of 10 (meters understood), with the minimum correction being 30. The direction of the deviation correction is opposite that of the spotting. The computed deviation correction is announced as “left” or “right” (so much) (meters understood). Table 3-2 on page 3-50 provides examples of how deviation corrections are made.

Table 3-1. Sequence of Subsequent Corrections.

Artillery/Mortars	NGF
Direction	Direction
Danger close	Danger close

Trajectory	Trajectory
Method of fire	Shell
Distribution	Fuze
Shell	Deviation ¹
Fuze ¹	Range ¹
Volume of fire	HOB ¹
Deviation ¹	Number of guns
Range ¹	Number of salvos
HOB ¹	Method of control ¹
Target description	
Change in type of mission/control ¹	
Splash	
Repeat ¹	
Notes: ¹ These commands constitute a command for the firing unit to deliver another round unless modified by the command "at my command."	

Example

OT distance = 2,400 meters; OT factor = 2
OT distance = 800 meters; OT factor = .8

Note

Large deviation corrections (e.g., right/left 400) may indicate an error in direction. This could be attributed to errors in initial target location, improper orientation of the OF fan, or malfunction of direction measuring equipment. When large corrections occur, the observer makes an appropriate check by verifying direction before continuing the mission. When necessary, he refines and transmits the new OT direction. Accuracy of adjustments depends, in part, on an accurate direction.

Table 3-2. Example of Computed Deviation Corrections.

Example	OT Distance (m)	OT Factor	Spotting	Deviation Correction
1	4,000	4	45 right	Left 180
2	2,500	2	100 left	Right 200
3	3,400	3	55 left	Right 160
4	1,500	2	20 right	Left 40
5	700	0.7	45 left	Right 30

d. Relationship of Observer-Target Line and Gun-Target Line and Dispersion. The relationship of the OTL to the GTL may influence the determination of deviation corrections. The natural dispersion along the GTL (more pronounced with NGF) limits the accuracy of some corrections. An observer whose OTL is perpendicular to the GTL makes deviation corrections that are actually range corrections for the weapons system. When this happens, the observer can overcorrect by spotting and correcting what is actually natural dispersion along the GTL.

(1) Artillery and Mortars. The angle formed by the intersection of the OTL and the GTL with the vertex of the angle at the target location is referred to as angle T. The observer is notified when angle T is significant enough to affect the adjustment of fire (500 mils or greater). When notified, the observer continues to make his deviation corrections as explained above. However, if he sees that the corrections are not taking their proper effect (e.g., a right 200 correction appears to shift right 300), the observer may consider adjusting his corrections proportionately to compensate for dispersion resulting from angle T, for example, cut the correction in half or thirds. (See figure 3-10 on page 3-52.)

(2) Naval Gunfire. The spotter must remain abreast of the OTL/GTL relationship because the characteristic flat trajectory of NGF results in a pronounced dispersion pattern along the GTL (range dispersion). The spotter must derive the OTL/GTL relationship from the prefiring report. He then visualizes the OTL/GTL relationship. The adjustment of NGF is discussed in detail in paragraph 3304.

e. Range Corrections. The observer must be aggressive in his conduct of the adjustment. He should strive to enter fire for effect as soon as possible. When conducting an adjustment onto a target, the observer makes range corrections along the OTL. Range corrections consist of the command “add” (move burst away from the observer) or “drop” (move burst closer to the observer). Range corrections are transmitted in multiples of 100 meters with the smallest correction being 100 meters. However, 50-meter corrections may be used when entering fire for effect. The methods

for conducting range corrections are successive bracketing, hasty bracketing, one-round adjustment, and creeping fire.

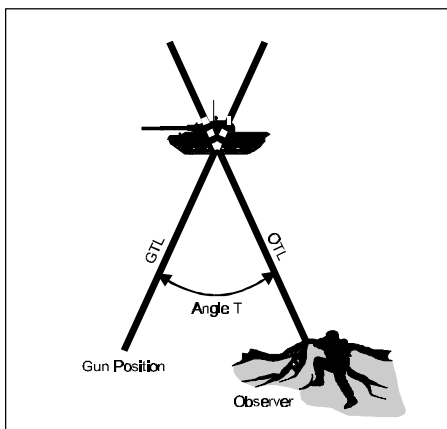

Figure 3-10. Angle T.

(1) Successive Bracketing. After a definite range spotting of over or short has been determined, the observer selects a range correction that is sufficiently large to ensure that the next round's impact is on the opposite side of the target from the previous round's impact. This essentially brackets the target between the two rounds. The observer selects a correction of add or drop 100, 200, 400, or 800 (meters understood) to achieve a bracket. Once a bracket has been established, corrections are made that successively split the bracket in half in multiples of 100-meter increments, always moving the next burst toward the target. The observer continues this process until a 100-meter bracket is established around the target or adjusting point. He then adds (or drops) 50

(with a deviation correction as required) and enters the fire-for-effect phase.

Note

On missions when PE_r is greater than 38 meters or on missions using shell dual-purpose improved conventional munitions (DPICM), M825, or family of scatterable mines (FASCAM), the fire-for-effect phase is entered after a 200-meter bracket has been established.

In NGF, once a 200-meter bracket is achieved, the spotter may enter fire for effect when engaging an area target such as a supply depot. If the observer fails to achieve a bracket on his initial correction, he retransmits another range correction until he achieves a bracket. Successive bracketing procedures are time consuming. This procedure should be used only when time is not critical and the situation requires this type of adjustment.

Example

The observer's spotting for the first round is "over, 75 mils left." Using an OT factor of two (OT distance = 2,400), the observer's first correction would be "right 150, drop 200." The next spotting is "short, 15 mils right." The observer transmits "left 30, add 100." The round impacts "short, five mils right." The observer transmits "add 50, fire for effect." (*No deviation corrections of less than 30 are made.*)

Note

Large range corrections (e.g., add/drop 800) may indicate an error in the initial OT factor calculated by the observer. By combining the initial distance to target with subsequent range corrections, a new OT factor can be refined.

Determine a new OT factor with bold range corrections. Accuracy in adjustment depends on an accurate OT factor.

(2) Hasty Bracketing. Experience has shown that effectiveness on the target decreases as the number of rounds used in adjustment increases. This is due to a loss of surprise. An alternative to successive bracketing is hasty bracketing. In this technique, the observer uses an initial bracket as a yardstick to determine a correction necessary to move the next round(s) onto the target in fire for effect. Hasty bracketing can achieve effective results depending on the nature of the target, the terrain, the firing unit's proficiency, and the observer's experience. However, hasty bracketing is difficult to use when adjusting NGF because of its characteristic dispersion pattern.

(3) One-Round Adjustment. Unlike the two adjustment techniques discussed above, this method does not require the establishment of a bracket. The observer spots the location of the first round, calculates and transmits a correction that is necessary to move the next burst onto the target, and fires for effect. One-round adjustment requires an experienced observer who is familiar with the terrain. This technique can be used when insufficient time exists for adjustment, when the observer is equipped with a laser rangefinder, or when the continued adjustment of fire may endanger the observer. The laser polar technique uses a one-round

adjustment because of the accuracy of its measurements. (See paragraph 9016.)

(4) Creeping Fire. The creeping fire method of adjustment is used when the observer desires to make range corrections by creeping the rounds closer to the target instead of bracketing or large corrections. This method of adjustment is always used in danger close missions. In danger close situations, the observer must keep in mind the position of the friendly troops to ensure that a correction will not cause rounds to endanger them. This may be applicable in situations where lost rounds are likely, for example, adjusting onto a target located on the topographic crest of a hill.

(a) In artillery and mortars, the observer makes corrections for creeping fire in 100-meter increments or less when moving rounds toward friendly forces. All mortars that will fire for effect are used in adjustment. For battalion missions, firing batteries should be adjusted individually.

(b) In NGF, the spotter moves each round in creeping fire toward the target in increments of 100 or 200 meters until effect is obtained. The combined effect of the correction should not exceed 200 meters toward friendly forces. If more than one gun is to fire for effect, the spotter should check the MPI of all guns to be used before entering fire for effect. Fires may be crept to within a minimum safety distance of the friendly position. Recommended minimum safety distances for adjusting salvos of a five-inch gun are 200 meters when firing parallel to front lines and 350 meters when not firing parallel to the front lines. The ship will normally advise

the spotter when the predicted fall of shot approaches the minimum safety distances.

f. Height-of-Burst Corrections. HOB corrections are used to adjust the difference in altitude between the impact of rounds and the target. HOB corrections are also used to make corrections for air bursts. (See paragraphs 3305. (artillery) and 3306. (naval gunfire).) HOB corrections are needed when attacking a target on a steep slope or for a target presenting a vertical face. The observer uses up or down corrections (in meters) to move the impact of the round. These corrections will allow the observer to get rounds on target with fewer adjustments than would be needed when using other corrections, that is, add/drop or right/left. When using up/down corrections, the observer adjusts to the target; that is, he does not bracket. (See figure 3-11.)

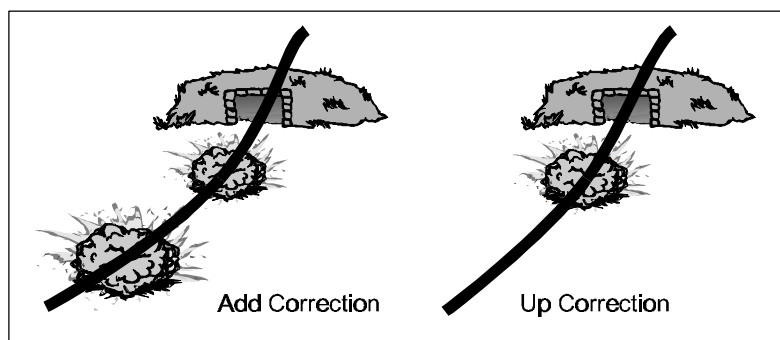

Figure 3-11. Examples of Corrections.

3303. Fire-for-Effect Phase

a. Conditions for Entering the Fire-for-Effect Phase. The fire-for-effect phase is entered when the deviation, range, and HOB (as applicable) are correct or if effective fire will result when the range bracket is split.

(1) Artillery and Mortars. The observer enters the fire-for-effect phase in the following situations:

- When an adjusting round has an effect on the target
- When splitting a 100-meter bracket
- When splitting a 200-meter bracket if notified by the FDC that the PE_R is 38 meters or larger or when firing shell DPICM, M825, or FASCAM.

(2) Naval Gunfire. The spotter enters fire for effect in the following situations:

- When an adjusting round has an effect on the target
- When splitting a 100-meter bracket for a point target
- When splitting a 200-meter bracket for an area target.

b. Procedures for Entering the Fire-for-Effect Phase. The fire-for-effect phase is entered in the following manner.

(1) Artillery and Mortars. The observer announces “fire for effect,” preceded by any corrections.

Example

“Fire for effect, over” or “right 30, add 50, fire for effect, over.”

(2) Naval Gunfire. The spotter transmits a correction as required, the number of guns if different from that used in adjustment or stated in the call for fire, and the number of salvos then announces “fire for effect.”

Example

“Right 30, add 50, six salvos, fire for effect.”

c. Procedures for Obtaining Additional Fire After Fire for Effect. The observer analyzes the results of the fire for effect. The situation may require additional rounds to be fired on the same location or a different location.

(1) Repeat. For *artillery and mortars*, if additional fire is needed, the observer announces “repeat.” The term “repeat” indicates the observer’s desire to use the same volume of fire.

(2) Adjust the Mean Point of Impact of the Fires. If the location of the fire needs to be moved to achieve satisfactory results, the observer announces the appropriate corrections (refinement) and “repeat” or reenters adjust fire.

Example

“Right 100, repeat, over.”
“Add 400, adjust fire (spotter adjust for NGF), over.”

For *NGF*, the spotter distributes the fire over an area target by announcing “spreading fires,” followed by a correction or repeat.

Example

“Spreading fires, right 100, repeat, over.”

d. Refinement. Refinement is given for all missions. Refinement is a term used in artillery to indicate a final correction to move the center of impact to the adjusting point. This correction may be less than 30 meters and is expressed to the nearest 10 meters.

Example

“Right 20, add 20.”

e. End of Mission. On achieving the effects desired on the target, the observer should transmit an end of mission statement to the firing unit. Four items are needed in the end of mission statement: refinement, record as target, end of mission, and surveillance (RREMS).

(1) Refinement. In artillery, if fires have been inaccurate but have produced sufficient results, the observer transmits a correction or refinement to the FDC.

Example

“Right 20, add 20, end of mission, RPG silenced, over.”

(2) Record as Target. If the observer wants the target to be plotted for future use, he announces “record as target.”

(a) In *artillery and mortars*, the FDC applies the refinement, conducts a replot when necessary, and announces the adjusted grid to the target. The target number should be the same number provided in the MTO.

(b) In *NGF*, the target number is assigned by the spotter.

Example

“Record as target, target number AB 1250, over.”

(3) End of Mission. “End of mission” followed by surveillance is the last transmission in the course of the fire mission. Once it has been announced, the mission is considered to be terminated.

(4) Surveillance. Surveillance should be brief but should provide casualty and/or damage information as accurately as possible. This requires the correct usage of the terms *destroyed*, *neutralized*, and *suppressed*, as addressed in appendix A.

Example

“End of mission, BMP neutralized, estimate six casualties, over.”
“Right 20, add 20, record as target, end of mission, three trucks destroyed,
estimate 15 casualties, over.”

3304. Naval Gunfire Adjustment Procedures. The flat trajectory and high muzzle velocity of NGF make the adjustment of NGF difficult, particularly on flat terrain. The spotter must use OF procedures (discussed previously in this chapter), such as accurate target location and bracketing. The spotter must also use the following procedures.

a. Identify the Gun-Target Line. When notified of the GTL in the prefiring report, the spotter must visualize its position in relation to the target and his own position. This will provide the basis for the spotter to identify round-to-round dispersion in adjustment.

b. Be Aware of the Dispersion Pattern of Naval Gunfire. The fall of shot of NGF can be described as a narrow, elongated pattern as seen along the GTL. The size of the pattern varies with range. For example, at 21,000 meters, the five-inch-gun mount will cause a round-to-round dispersion pattern that is approximately 150 meters long and 50 meters wide. Figure 3-12 on page 3-62 displays the NGF dispersion pattern.

c. Predict Each Fall of Shot Before Impact. While the ship is determining firing data for the next round, the spotter should visualize the fall of shot based on his corrections. The spotter compares the actual impact of the round with the predicted fall of

shot. Differences that occur along the GTL may indicate round-to-round dispersion.

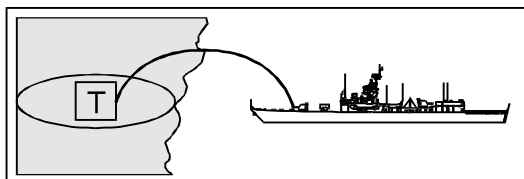

Figure 3-12. Naval Gunfire Dispersion Pattern.

d. Ignore Errors to the Fall of Shot Attributed to Round-to-Round Dispersion. When a round has impacted contrary to its predicted fall of shot due to dispersion, the spotter makes a correction from its predicted point of impact instead of its actual point of impact. This correction should result in the next fall of shot impacting as predicted. It also keeps the spotter from getting a ping-pong effect in adjustment. (See figure 3-13 on page 3-63.)

e. Correct From the Mean Point of Impact. The MPI is “the point whose coordinates are the arithmetic means of the coordinates of the separate points of impact/burst of a finite number of projectiles fired or released at the same aiming point under a given set of conditions.” (Joint Pub 1-02) When consecutive rounds impact differently from their predicted fall of shot, the spotter should make a correction from the average or MPI of the rounds. (See figure 3-14 on page 3-63.)

The spotter visualizes the GTL. His first spotting is "Short, 35 mils right" (OT factor = 2). He transmits a correction of "Left 70, add 200." His predicted fall of shot is "Over, on line (A)." The second spotting is "Over, 25 mils left." (The apparent error is along the GTL.) The spotter transmits a correction of "Drop 100." The third spotting impacts as predicted "Short on line (B)." The spotter's final correction is "Add 50, five salvos, fire for effect."

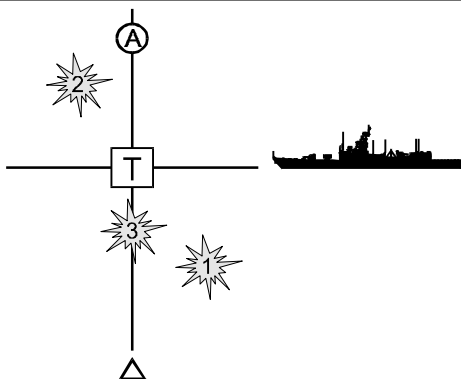

Figure 3-13. Example of Dispersion.

The first spotting is "Short, 35 mils right" (OT factor = 2). The first correction is "Left 70, add 200." The predicted fall of shot is "Over, on line (A)." The second spotting is "Over, 25 mils left." (The apparent error is along the GTL.) The spotter transmits a correction of "Drop 100." The predicted fall of shot is "Short, on line (B)." The third spotting impacts "Short, 30 mils left." The spotter notes that two consecutive rounds have impacted "left" of their predicted points of impact (A and B). The final correction is "Right 50, add 50, five salvos, fire for effect." Note that the spotter made his deviation correction from the MPI of the last 2 rounds ("25 mils left" and "30 mils left").

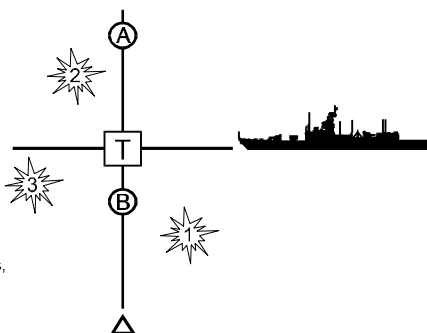

Figure 3-14. Adjustment of Mean Point of Impact.

f. Multiple Rounds in Adjustment. There may be times when the spotter needs to adjust with multiple rounds, to fire multiple salvos from a single gun, or to use multiple guns in adjustment. The

multiple-rounds-in-adjustment technique requires the spotter to adjust from the MPI of all rounds fired. This technique is normally used when firing on a large-area target or when visualizing the GTL. This technique can also be used by spotters who are experiencing difficulties in range dispersion during adjustment.

g. Elevation/Height-of-Burst Adjustment of Impact Fires. On steep terrain, up or down corrections are essential in the adjustment of NGF. The spotter uses the corrections to bring the fall of shot to the same elevation as the target. Up and down corrections will be reflected on the ground with reference to the GTL. The spotter transmits up or down corrections in increments of five meters. The spotter can use the map to help determine these corrections. The spotter should avoid mixing add or drop with up or down corrections for impact fires because both of these corrections involve an elevation change on the gun and the results would be unpredictable. Deviation and range adjustments along the OTL will usually equate to elevation changes on the gun when transformed to GTL corrections. The spotter should use up or down corrections to bring the impacts to the same altitude as the target then switch to deviation and/or range corrections.

3305. Adjusting Artillery Air Bursts. Two types of fuzes that create an air burst with shell HE are mechanical time fuzes, called time, and proximity fuzes, called VT. When firing fuze time, the FO must adjust the HOB. The adjustment of air bursts is made by using HOB spottings to determine a correction. The firing battery fires one gun in adjustment. VT fuzes do not require adjustment.

a. Time Fuze Procedures

(1) Adjustment. HOB adjustment follows the adjustment of HE/Q. HE/Q is adjusted for deviation and range to within 50 meters of the target. The FO then initiates the firing of an air burst by announcing “time repeat” or “time . . . ” followed by a deviation and/or range correction. When an air burst detonates, the HOB spotting (to the nearest mil) is multiplied by the OT factor to determine a correction in meters. The correction is made to cause the next air burst to detonate 20 meters above the target. The correction is transmitted as an up or down correction followed by the number of meters (understood to be meters). Deviation or range corrections are not made after entering the time phase.

(a) Graze Burst. If the initial round is a graze spotting, then an automatic correction of “up 40” is made. Subsequent “up 40” corrections are given until an air burst is achieved. Consecutive graze spottings may indicate an error by the battery, for example, improper fuze setting, or an error by the observer in target location altitude. The FO must avoid making deviation and range corrections from a graze burst unless he is unable to achieve effects on target.

(b) Corrections. When making HOB corrections, the FO must be aware of the gunnery solution and its effect on the round. (See figure 3-15 on page 3-66.) When a HOB correction is given by the FO, the FDC converts the HOB correction to a fuze setting correction for the mechanical time fuze. An up HOB correction will result in a decrease in the fuze setting; a down correction will result

in an increase in the fuze setting. The change in fuze setting will change the point of detonation along the trajectory of the round. In addition to achieving a change in HOB, the FO will also see a change in range. An up correction will result in the round detonating short of the target; a down correction will result in the round detonating closer to the target.

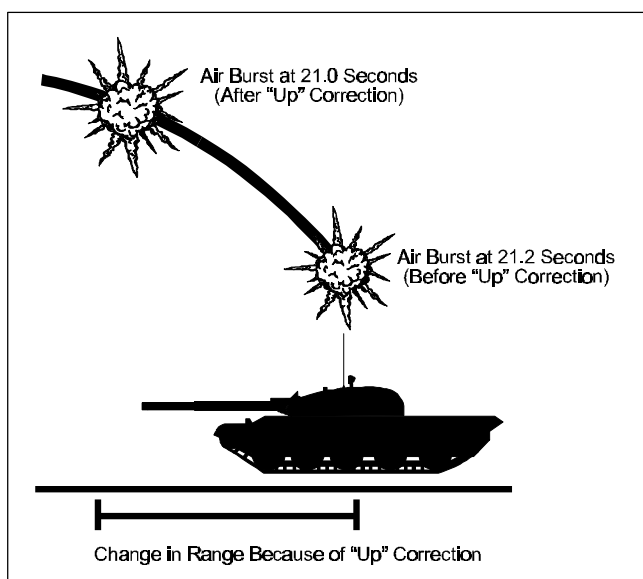

Figure 3-15. Effect of Height of Burst Corrections on Burst of Round.

(2) Fire for Effect. When an air burst is achieved, the fire-for-effect phase is entered if the FO believes that the HOB correction will result in a 20-meter HOB. Fire for effect is never begun if the last

round observed was spotted as “graze” or if the HOB correction is greater than 40 meters.

Example
“Down 10, fire for effect, over.”

There are several possible spottings for the initial fire-for-effect volley, including air, mixed, mixed air, and mixed graze. (See paragraph 3301.) If additional fire, or sending refinements, is required to achieve effects, the following corrections can be made. For air, adjust the mean HOB to 20 meters. For mixed, the correction is “up 10.” For mixed air, the HOB is correct. For mixed graze, the correction is “up 20.”

(3) Fire-for-Effect Missions. Time fuzes are normally selected for adjust-fire missions because of the requirements to achieve an effective HOB. However, it is possible to initially fire for effect with time fuzes if a registration has been conducted with that fuze lot. The closer the target is to the registration point, the greater the likelihood of achieving effects without adjustment.

b. Proximity Time Fuze Procedures

(1) Adjustment. VT fuzes require no adjustment before firing for effect. The fire-for-effect phase is entered after the appropriate bracket is established with the adjusting shell and fuze. VT fuzes should always achieve an air burst.

(2) **Fire for Effect.** VT fuzes achieve their seven-meter HOB by using radar, not the time setting on the fuze. Graze bursts of an entire volley indicate either a computational error by the battery, for example, improper fuze setting; an error by the observer in target location altitude; or a malfunctioning lot of fuzes. In the case of graze bursts with VT, the *spotting* of graze is transmitted to the FDC.

Example

“Graze, repeat, over.”

The FDC then subtracts one second from the fuze arming time in an attempt to overcome computational or observer error. Factors affecting the performance of VT fuzes and possibly creating premature air bursts include snow, water, and intervening crests.

3306. Adjusting Naval Gunfire Air Bursts. Time fires use special fuzes to achieve an air burst over the target. These fuzes include mechanical and electronic time fuzes that require a time setting before firing. Air bursts may also be delivered by proximity fuzes (VT and fuze controlled variable time (CVT)) designed to explode at an optimal HOB (20 meters for five-inch NGF) based on a radio-activated signal. Time fires using time or electronic time fuzes require adjustment to ensure detonation at an optimal HOB (20 meters) in fire for effect. Proximity fuzes do not require adjustment.

a. Adjustment of Time Fires. The observer announces “fuze time in effect” in the method-of-engagement element of his call for fire.

He conducts adjustment with fuze quick in the same manner as discussed previously in this chapter. He enters the time phase of the adjustment process in the following situations:

- When splitting a 200-meter bracket for an area target
- When splitting a 100-meter bracket for a point target
- When an adjusting round has an effect on the target.

The transmission to enter into the time phase of adjustment is “fuze time” followed by a correction (or repeat).

Examples

“Fuze time, right 30, add 50, over.”

“Fuze time, repeat, over.”

b. Height-of-Burst Corrections. If the initial time round is spotted as a graze, then the correction is “up 40.” A 40-meter HOB correction will be applied until a spotting of “air” is obtained. Consecutive graze spottings may indicate an error in the altitude of the target reported in the call for fire or an error by the mechanical fuze setter on the gun. The spotter must avoid making deviation and range corrections from a graze burst. Usually, a graze burst will be over the target on the GTL. Once an initial air spotting is achieved, the spotter measures the spotting to the nearest mil and computes a HOB correction by multiplying the spotting by the OT factor. The HOB correction is made to the nearest five meters to correct the HOB to 20 meters. If a correct HOB can reasonably be

3-70

expected, the spotter enters fire for effect. If the air spotting is excessively high (60 meters or greater), then the spotter should observe another salvo before entering fire for effect. Excessively high bursts are normally short on the GTL and out of the target area because the fuze functioned prematurely in the projectile's trajectory. If a graze burst is obtained after an air burst, the correction is "up 20." Fire for effect is never begun when the last burst observed results in a graze spotting.

Chapter 4

Requesting and Controlling Close Air Support

This chapter provides procedures for requesting and controlling both fixed- and rotary-wing CAS. Normally, the terminal control of CAS aircraft is conducted by FACs. However, in combat or emergency situations where a FAC is not available, other Marines who are knowledgeable of these procedures, particularly observers and spotters, may request CAS and function as the terminal controllers for CAS aircraft. An understanding of these procedures by observers and spotters also enhances the coordination of missions that integrate indirect fires and CAS. Because these procedures are applied by all Marines requesting or controlling CAS, including Marines who are not formally trained or designated as FACs, this chapter will refer to the CAS requester and controller generically as the *terminal controller*. The CAS procedures discussed here are oriented to high-threat conditions because these are the most difficult to understand and the most demanding that may be encountered in the battlespace. In lower threat situations, these procedures may be streamlined. More detailed discussion of CAS terminal control procedures can be found in MCWP 3-23.1.

4001. Types of Close Air Support. There are two types of CAS that are available to support the ground forces: preplanned and immediate. The type used depends on the time available for planning.

a. Preplanned. Preplanned CAS is an airstrike on a target that can be anticipated sufficiently in advance to permit detailed mission

coordination and planning. These missions are categorized as scheduled or on call. A scheduled mission is executed at a specific time. An on-call mission involves aircraft placed in a ground/air alert status and preloaded with ordnance for a particular target or type of target.

b. Immediate. Immediate CAS is an airstrike on a target of opportunity that was not identified or requested sufficiently in advance to permit detailed mission coordination or planning. An immediate mission is the type with which the observer and the spotter will commonly be involved, and it requires impromptu coordination.

4002. Levels of Threat. The employment of CAS will likely be against an enemy who presents an air defense threat. This threat will affect the employment of CAS. The feasibility of using CAS on a specific target will be driven, in part, by the threat. Attack tactics selected by the aircraft pilot or flight leader will be influenced by the threat. Attack tactics are the specific tactics used in attacking a target. The greater the threat, the lower the altitude; the higher the dive angle, the more accurate the delivery. The threat to CAS may be high, medium, or low.

a. High Threat. A high threat is an environment created by a hostile force massing heavy combat power, including an Integrated Air Defense System (IADS) and electronic warfare capabilities that would seriously diminish the ability of the ACE to provide necessary air support. In this type of threat, aircraft tactics are

normally characterized as fast and low. This results in a minimal time for target acquisition, which may affect accuracy.

b. Medium Threat. A medium threat is an environment in which the enemy possesses a limited radar/electro-optical acquisition air defense system that is not fully integrated. Specific aircraft performance and associated weapons systems permit tactics that allow acceptable exposure to those enemy defenses.

c. Low Threat. A low threat is an environment where no known integrated/sophisticated surface-to-air or air-to-air capability exists. The threat is limited to visual target acquisition and fire control systems, that is, small arms, large-caliber automatic weapons, and shoulder-fired infrared missiles. In this type of threat, aircraft tactics may be fast or slow, at low to medium altitude, with ample time to acquire the target.

4003. Airspace Control Measures. Airspace control measures are procedural control measures designed to maximize the effectiveness of combat operations by promoting the safe, efficient, and flexible use of airspace. Airspace control measures are used to delineate or modify hostile criteria, delegate target identification authority, or serve as aids for fire control. Airspace control measures speed handling and control of aircraft over the battlespace. Air control agencies such as the DASC or Navy TACC use these measures in directing aircraft to and from the target area. Terminal controllers and observers must understand the meaning of each of these measures.

a. Control Point. Control points route aircrews to their targets and provide a ready means of conducting fire support coordination. Control points must be easily identified from the air and support the MAGTF's scheme of maneuver. The MAGTF force fires coordination center (FFCC) and the ACE select control points based on MAGTF requirements. The MAGTF commander approves control points. Control points are given names or numbers and are often used to facilitate the establishment of airspace coordination areas (ACAs) for aircraft operating in areas where flight routes or tactics can conflict with indirect-fire trajectories.

b. Contact Point. A contact point is the position at which an aircrew makes radio contact with an air control agency. Normally, a contact point is outside the range of enemy surface-to-air weapons. The aircrew contacts the terminal controller at the contact point during ingress. A contact point allows coordination of final plans before heavily defended airspace is entered.

c. Initial Point. Aircrews use an initial point (IP) to start their run to the target or their approach to a landing zone. IPs are well defined and easily identified (visually or electronically). Terminal controllers and aircrews use IPs to help position fixed-wing CAS aircraft delivering ordnance.

d. Holding Area. Holding areas are areas well forward in the battlespace that provide for helicopter dispersion as well as cover and concealment from enemy observation and fires. Holding areas may be located at maneuver regimental or battalion headquarters or at the terminal controller's position. Rotary-wing CAS aircrews

normally occupy holding areas while awaiting targets or missions. While in the holding area, rotary-wing CAS aircrews receive CAS briefings and perform final mission coordination with terminal controllers.

e. Battle Position. Battle positions are maneuvering areas that also contain various firing points, both laterally and in depth. Helicopters maneuver in battle positions while awaiting the TOT or time to target (TTT). They are coordinated and selected by the supported commander. Once the terminal controller clears rotary-wing CAS aircraft into a battle position, these aircraft should not exit until authorized. Aircrews have freedom of movement within the battle position unless restricted by the flight leader. To avoid enemy counterfire, aircraft may need to displace and resume the attack from a different battle position. Therefore, alternate battle positions should be established. Terminal controllers should consider requesting ACAs around battle positions. If an approved battle position does not exist, aircrews can plan a hasty battle position in coordination with the terminal controller. If there is not a properly placed or existing battle position, the terminal controller may create a new battle position. Terminal controllers identify the battle position by grid, known point, or prominent terrain or by shifting an existing battle position. The positions of new battle positions must be given to the appropriate FSCC for fire support coordination. Battle position selection is based on the following factors.

(1) Field of Fire. The battle position should permit the sighting of targets throughout the kill zone.

(2) **Adequate Maneuver Area.** The battle position must be large enough for rotary-wing CAS aircrews to maneuver between various firing points.

(3) **Range.** The battle position should be located so that the kill zone is within the effective range of rotary-wing CAS aircraft.

(4) **Target Altitude.** The battle position should be at an elevation equal to or higher than the target area.

(5) **Background.** Terrain features behind the battle position should prevent rotary-wing CAS aircraft from being silhouetted against the horizon.

(6) **Sun/Moon.** If possible, the sun or moon should be located behind or to the side of the aircraft. This allows the rotary-wing CAS aircrews to view the kill zone and prevents the enemy from seeing and targeting the aircraft.

(7) **Shadow.** If possible, terrain or vegetation should cover the battle position with shadows.

(8) **Rotor Wash.** The battle position location should reduce the effects of rotor wash on surrounding terrain, for example, debris, leaves, snow, sand, and dirt.

(9) **Backblast.** The battle position location should reduce the effects of backblast on surrounding terrain.

4004. Coordination Techniques

a. Run-In Heading. The run-in heading is the heading from the IP to the target. For rotary-wing CAS aircraft, this may be the heading from the center of the battle position to the target. The terminal controller determines this heading from his map and converts it to a magnetic heading for transmission in the brief. The assignment of run-in headings facilitates fire support coordination by establishing a corridor for the aircraft between the IP and the target. Without a run-in heading, the aircrews may exercise a number of options for proceeding from the IP to the target. The decision to use run-in headings depends on factors such as target orientation, terrain, disposition of defense, and weather.

b. Offset Direction. An offset direction is used to ease fire support coordination, safeguard friendly forces, aid target acquisition, or align aircraft for the attack or egress. The offset direction tells the aircrew on which side of the IP-to-target line they can maneuver for the attack. An offset direction aids fire support coordination by restricting aircrews from using airspace on the other side of the IP-to-target line. It keeps aircraft clear of enemy air defenses and reduces interference with GTLs. It also reduces an aircrew's chance of being hit by friendly direct and indirect fires.

Note

During combat, the danger to aircraft from friendly direct/indirect fires is quite small compared to the threat from enemy air defenses. The offset direction regulates the attack quadrant without assigning a specific attack heading. This technique protects friendly ground forces from range errors in the delivery of ordnance without unduly restricting the attacking aircraft.

c. Attack Heading. An attack heading is the assigned magnetic compass heading that an aircrew flies during the ordnance-delivery phase of the attack. Terminal controllers assign attack headings for several reasons: to improve ground troop safety, to aid in target acquisition, and to ease fire support coordination. Attack headings, especially during visual attacks, may reduce the flexibility and survivability of aircraft.

d. Pullup Point. The pullup point is important in low-level attacks because it is the point at which the fixed-wing CAS aircraft begins to climb to identify the target and to gain altitude to strike the target. Pullup points are selected by the pilot and will vary depending on the type of aircraft, type of attack intended, and experience of the aircrew.

e. Attack Routes. Rotary-wing CAS aircrews use attack routes to move from the holding area to the battle position. Aircrews select primary and alternate attack routes. If an ACA is required, the aircrew or terminal controller coordinates with the appropriate FSCC. The ideal attack route is a corridor that allows aircrews to move into the battle position undetected. Detection, even if beyond the range of enemy air defense weapons, removes the advantage of

surprise. Terrain and vegetation are used to conceal aircraft movement on the attack route. SEAD fires may also be employed to conceal aircraft movement and prevent detection.

f. Firing Points. A firing point is a specific point within a battle position that a single aircraft occupies while engaging targets. The flight leader determines movement of aircraft within the battle position. Aircrews choose their own firing points even though the supported commander coordinates and controls the location of the battle position. Alternate firing points should be identified so that aircrews can displace after the initial engagement.

4005. Aircraft Ordnance. A knowledge of aircraft ordnance is important for the proper employment of CAS. This information allows the terminal controller to know the effects that can be produced on the target and to make target marking and airspace coordination compatible with the type of delivery.

a. General-Purpose Bombs. General-purpose, MK-80-series bombs are among the most widely used weapons in the inventory. When fuzed for instantaneous detonation, they provide good fragmentation effects for use against personnel and light equipment. When fuzed for delayed detonation, they can be used to create obstacles (e.g., cratering rounds). Retarding devices, called snake-eye fins and ballute, can be attached to MK-82-series and MK-83-series bombs. With these devices, it is possible to deliver ordnance in a low-altitude delivery. (See table 4-1 on page 4-10.)

Table 4-1. Designations for General-Purpose Bombs.

Type	Size	Delivery Means
MK-82 aircraft	500 lb	All fixed-wing CAS aircraft
MK-83 aircraft	1,000 lb	All fixed-wing CAS aircraft
MK-84 aircraft	2,000 lb	All fixed-wing CAS aircraft (except AV-8B)

The fragmentation pattern varies with the size, configuration, and method of delivery of the bomb. An MK-82 with snake-eye fins (delivered by an F/A-18 at 2,500 feet above ground level with a release angle of 30 degrees) can produce a ground pattern with fragments dispersed up to 1,000 meters on either side of the point of impact. See appendix A for minimum safe distances.

b. Firebombs. The MK-77 is the primary firebomb. Firebombs have a very erratic trajectory and must be released at a very low altitude to achieve desired accuracy. A typical ground pattern for the MK-77 is elliptical in shape and is approximately 215 feet long in the direction of delivery and 75 feet wide. This ordnance can be delivered from all CAS aircraft.

c. Cluster Bomb Unit Weapons. The cluster bomb unit (CBU) weapon consists of one type of bomb casing filled with a large number of either antipersonnel, antimateriel, or antitank munitions. The CBU weapon is designed to provide a high kill or damage probability against area, moving, and point targets. CBU weapons can be employed from all CAS aircraft. The CBU weapon inventory includes the following.

(1) **MK-20 Rockeye.** This is an area weapon designed for antiarmor use. It can also be used against other targets, such as trucks, missile sites, radars, and fuel storage tanks.

(2) **CBU-59/B Antipersonnel/Antimaterial Weapon.** This weapon is highly effective against both personnel and lightly armored equipment under a wide variety of terrain conditions. The bomblets function as shaped-charge devices against light to medium armor and as fragmentation devices against soft targets. Antipersonnel/antimaterial (APAM) weapons are highly effective against parked trucks, armored personnel carriers, and so on.

(3) **CBU-78/B Gator.** Gator provides a means for rapidly planting a minefield. The mines are extremely effective against armored vehicles and personnel for area denial and harassment. The ability to select from three self-destruction times for the mines allows tactical counterattack by friendly forces.

d. Rockets. There are two types of air-to-surface rockets in the Marine Corps inventory—the 2.75-inch folding-fin aircraft rocket (FFAR) and the 5-inch Zuni rocket. These rockets, with the selection of warheads available, provide an effective attack against a variety of targets. Rockets can be employed from all CAS aircraft.

(1) **2.75-inch Folding-Fin Aircraft Rocket.** These rockets are normally fired in ripple (rapid repeat); this increases the probability of hits. The warheads available are fragmentation, antiarmor shaped charge, smoke, flare, and flechette.

(2) **5-inch Zuni.** These rockets can be fired singly or in ripple, with fragmentation, antiarmor shaped charge, or WP warheads.

e. Air-to-Surface Guided Missiles. Various air-to-surface missiles are available in the CAS inventory. Some of these are discussed below. Laser-guided missiles are discussed in chapter 9.

(1) **Walleye Weapons System.** Walleye is an air-to-surface glide bomb that uses automatic video tracking for homing and guidance to surface targets. This weapon is most effective against heavily structured, well-defined targets in daylight/clear weather conditions. Walleye can be employed from all fixed-wing CAS aircraft except the AV-8B.

(2) **M-65 Airborne Tube Launched, Optically Tracked, Wire Command Link Guided Missile System.** This weapon provides the capability to conduct a point target attack of armor at a maximum effective range of 3,750 meters. It is employed from attack helicopters.

(3) **AGM-114B Helicopterborne Fire and Forget Missile.** The helicopterborne fire and forget missile (HELLFIRE) is a laser-guided antiarmor missile. It provides pinpoint accuracy from a safe standoff distance. HELLFIRE can currently be employed only from the AH-1W, AH-64, and OH-58D.

(4) **AGM-65 Maverick Missile.** The Maverick missile is used against field fortifications and armored vehicles. There is a laser-guided variant (AGM-65E) and an imaging infrared-seeker

variant (AGM-65F). The Maverick is employed from the F/A-18 and AV-8B.

f. Fuel Air Explosive Weapons. The HE force of the fuel air explosive weapon creates an overpressure that can be effective against mines, boobytraps, and personnel. The bombs are parachute retarded and have a degree of target discrimination that allows them to penetrate light foliage without detonation. This ordnance can be employed from all CAS aircraft.

g. Guns. Aircraft employ various guns, including the 20-mm, 25-mm, and 30-mm weapons. Aircraft guns are accurate and highly effective against a variety of linear targets, such as truck convoys, a column of troops, and so on. All CAS aircraft can employ guns.

h. Flares. All CAS aircraft can employ flares (MK-45/LUU-2), which provide illumination of the target area for up to three minutes (flare dependent).

4006. Close Air Support Request and Control Procedures. The terminal controller normally follows a sequence of events that will provide the essential information needed by those who must approve the mission, coordinate the mission, and fly the mission. The sequence of events is as follows: request, brief, time, mark, adjust, control, and report.

4007. Request. Requests for immediate CAS missions are made to support requirements that arise during battle and that cannot be identified far enough in advance to permit detailed mission

coordination and planning. Immediate missions provide crisis response to unforeseen dilemmas and sacrifice detailed planning and tailored ordnance loads in return for timely response. Requests for immediate CAS are normally transmitted on the TAR net by the requester directly to the air control agency (normally the DASC). The air officers at intermediate-echelon FSCCs monitor the requests for coordination purposes and indicate approval in the method prescribed by the commander—either positive or passive clearance. The format used for immediate requests corresponds to the appropriate lines of the joint tactical airstrike request (JTAR). (See figure 4-1 on pages 4-16 and 4-17 and MCWP 3-23.1.) The request may be made in one transmission or in separate bursts, consistent with the communications security situation, and should include pertinent lines from the JTAR. Requests for preplanned CAS missions are submitted by using the same JTAR format but are submitted to the appropriate FSCC for consolidation, approval, and forwarding to higher echelon FSCCs.

a. Elements of the Immediate Request

(1) Identification of Unit Called/Requester. This element includes the call signs of the unit called and the requester, followed by the words “immediate CAS.” The transmission of “immediate CAS” prioritizes the mission for responsiveness.

(2) Mission Category. The mission category for an immediate CAS mission is indicated by announcing “immediate” and the mission priority. The following numerical designations are used to define the tactical situation.

(a) 1—Emergency. Targets that require immediate action and supersede all other categories of mission priority.

(b) 2—Priority. Targets that require immediate action and supersede routine targets.

(c) 3—Routine. Targets of opportunity that do not demand urgent execution.

(3) Target Description. The target is described by type, size, and mobility. This information is used in mission processing to determine the type and number of aircraft and type and amount of ordnance needed for the mission.

(4) Target Location. The target location is provided by using the UTM 100,000-meter-square designation and grid coordinates (e.g., SS623 456) and the elevation in feet (mean sea level). The ordnance delivery systems of F-14, F/A-18A, older model F/A-18C, and some U.S. Air Force aircraft require latitude/longitude rather than UTM grid. (See appendix F.) Although all pilots can manually convert UTM grid to latitude/longitude if necessary, it is generally easier for a trained terminal controller to make this conversion. Pilots who are distracted by threat conditions or other flight requirements may specifically request latitude/longitude if a UTM grid is given. (See figure 4-2 on page 4-18.)

JOINT TACTICAL AIR STRIKE REQUEST			See JCS Pub 12, Vol II, for instructions for preparation.					
SECTION I - MISSION REQUEST			DATE					
1. UNIT CALLED	THIS IS	REQUEST NUMBER		SENT				
			TIME	BY				
PREPLANNED: <input type="checkbox"/> A PRECEDENCE _____ <input type="checkbox"/> B PRIORITY _____ IMMEDIATE: <input type="checkbox"/> C PRIORITY _____			RECEIVED					
			TIME	BY				
TARGET IS/NUMBER OF <input type="checkbox"/> A PERS IN OPEN _____ <input type="checkbox"/> B PERS DUG IN _____ <input type="checkbox"/> C WPNS/MG/RR/AT _____ <input type="checkbox"/> D MORTARS, ARTY _____ <input type="checkbox"/> E AAA, ADA _____ <input type="checkbox"/> F RKTS MISSILE _____ <input type="checkbox"/> G ARMOR _____ <input type="checkbox"/> H VEHICLES _____ 3. <input type="checkbox"/> I BLDGS _____ <input type="checkbox"/> J BRIDGES _____ <input type="checkbox"/> K PILL BOX, BUNKER _____ <input type="checkbox"/> L SUPPLIES, EQUIP _____ <input type="checkbox"/> M CENTER (CP, COM) _____ <input type="checkbox"/> N AREA _____ <input type="checkbox"/> O ROUTE _____ <input type="checkbox"/> P MOVING N E S W _____ <input type="checkbox"/> Q REMARKS _____								
TARGET LOCATION IS 4. <input type="checkbox"/> A _____ <input type="checkbox"/> B _____ <input type="checkbox"/> C _____ <input type="checkbox"/> D _____ (COORDINATES) (COORDINATES) (COORDINATES) (COORDINATES) <input type="checkbox"/> E TGT ELEV _____ <input type="checkbox"/> F SHEET NO _____ <input type="checkbox"/> G SERIES _____ <input type="checkbox"/> H CHART NO _____			CHECKED					
			BY					
TARGET TIME/DATE 5. <input type="checkbox"/> A ASAP _____ <input type="checkbox"/> B NLT _____ <input type="checkbox"/> C AT _____ <input type="checkbox"/> D TO _____								
DESIRED ORD/RESULTS <input type="checkbox"/> A ORDNANCE _____ 6. <input type="checkbox"/> B DESTROY _____ <input type="checkbox"/> C NEUTRALIZE _____ <input type="checkbox"/> D HARASS/INTERDICT _____								
FINAL CONTROL 7. <input type="checkbox"/> A FAC/RABFAC _____ <input type="checkbox"/> B CALL SIGN _____ <input type="checkbox"/> C FREQ _____ <input type="checkbox"/> D ASRT _____ <input type="checkbox"/> E * FREQ _____ <input type="checkbox"/> F FIX/CONT PT _____								
8. REMARKS 1. IP _____ 2. HDG _____ ° MAG _____ OFFSET: L/R _____ 3. DISTANCE _____ 4. TGT ELEVATION _____ FEET MSL 5. TGT DESCRIPTION _____ 6. TGT LOCATION _____ 7. MARK TYPE _____ CODE _____ 8. FRIENDLIES _____ 9. EGRESS _____ 10. BCN-TGT _____ ° MAG _____ BCN GRID: / _____ 11. BCN-TGT _____ METERS _____ TGT GRID: / _____ 12. BCN ELEVATION _____ FEET MSL								
			<table border="1" style="width: 100%; border-collapse: collapse;"> <tr><td style="text-align: center;">ACKNOWLEDGED</td></tr> <tr><td style="text-align: center;">BDE/REGT</td></tr> <tr><td style="text-align: center;">DIVISION</td></tr> <tr><td style="text-align: center;">OTHER</td></tr> </table>		ACKNOWLEDGED	BDE/REGT	DIVISION	OTHER
ACKNOWLEDGED								
BDE/REGT								
DIVISION								
OTHER								

Figure 4-1. Joint Tactical Airstrike Request (Section I).

SECTION II - COORDINATION											
9. NGF	10. ARTY	11. AIO/G-2/G-3									
12. REQUEST <input type="checkbox"/> APPROVED <input type="checkbox"/> DISAPPROVED	13. BY	14. REASON FOR DISAPPROVAL									
15. RESTRICTIVE FIRE/AIR PLAN <input type="checkbox"/> A IS NOT <input type="checkbox"/> B NUMBER	16. IS IN EFFECT <input type="checkbox"/> A (FROM TIME) _____ <input type="checkbox"/> B (TO TIME) _____										
17. LOCATION <input type="checkbox"/> A _____ <input type="checkbox"/> B _____ (FROM COORDINATE) (TO COORDINATE)	18. WIDTH (METERS)	19. ALTITUDE/VERTEX <input type="checkbox"/> A _____ <input type="checkbox"/> B _____ MAXIMUM VERTEX MINIMUM									
SECTION III - MISSION DATA											
20. MISSION NUMBER	21. CALL SIGN	22. NO. AND TYPE AIRCRAFT	23. ORDNANCE								
24. EST/ACT TAKEOFF	25. EST TOT	26. CONT PT/RDNVS (COORD NAVAID FIX)	27. INITIAL CONTACT								
28. FAC/ASRT/TAC (A) CALL SIGN FREQ	29. RESTRICTIVE FIRE/AIR PLAN (SEE 15-19)	30. TGT DESCRIPTION	*31. TGT COORD/ELEV								
32. BATTLE DAMAGE ASSESSMENT (BDA) REPORT											
<input type="checkbox"/> A TARGET COORD _____ <input type="checkbox"/> B TIME ON/OFF _____ <input type="checkbox"/> C % ORD ON TGT/ % TGT DESTROYED _____ <input type="checkbox"/> D RESULTS _____ <input type="checkbox"/> E UNIT SUPPORTED _____											
			<table border="1" style="width: 100%; border-collapse: collapse;"> <tr><td style="width: 20px;"></td><td>ACKNOWLEDGED</td></tr> <tr><td></td><td>BDE/REGT</td></tr> <tr><td></td><td>DIVISION</td></tr> <tr><td></td><td>OTHER</td></tr> </table>		ACKNOWLEDGED		BDE/REGT		DIVISION		OTHER
	ACKNOWLEDGED										
	BDE/REGT										
	DIVISION										
	OTHER										
*TRANSMIT AS APPROPRIATE											

Figure 4-1. Joint Tactical Airstrike Request (Section II).

Transmission:	
Terminal controller:	"Budworth, this is Tiger 14 with an immediate CAS request, over."
Terminal controller:	"Immediate, priority 2, five armored vehicles moving in column, SS623 546, elevation 55, ASAP, Tiger 14, Orange, Chevy, friendly troops 1,000 meters south, over."
Description of Transmission:	
Unit called/request identification	Budworth, this is Tiger 14 with an immediate CAS request, over.
Mission category	Immediate, priority 2
Target description	Five armored vehicles moving in column
Target location	SS623 546, elevation 55
TOT	As soon as possible (ASAP)
Desired ordnance/results	(Not normally transmitted)
Final control	
Call sign	Tiger 14
Frequency	Orange
Contact point	Chevy
Remarks	Friendly troops 1,000 meters south, over.

Figure 4-2. Example of Immediate Request.

(5) Time on Target. The time at which the ordnance is desired on the target may be specified as "ASAP" (meaning that the target is to be attacked as soon as possible); as "TOT NLT _____" (meaning that the target is to be attacked no later than (NLT) the specified time on a synchronized clock); or as "TOT _____"

(which provides a specified time on a synchronized clock when the target is to be attacked).

(6) Desired Ordnance/Results. This element is not normally transmitted in the immediate request because responsiveness overrides ordnance selection.

(7) Final Control. This element identifies the terminal controller who will conduct the attack briefing and control the release of ordnance. It includes the call sign of the terminal controller, the frequency recommended for terminal control, and the contact point or IP to be used. The frequency is normally transmitted by using a preestablished color code pertaining to a selected frequency. The frequency modulation (FM) may be ultrahigh frequency (UHF) or VHF, depending on the type of aircraft.

(8) Remarks. This element provides any additional information that may assist the air control agency in mission processing, for example, friendly location, weather, threats, and so on.

b. Processing and Routing of the Request

(1) Mission Clearance. The air officers at intermediate-echelon FSCCs monitor requests for immediate CAS missions for coordination purposes. Mission clearance is conducted in the method prescribed by the commander—either positive or passive clearance. Under positive clearance procedures, each request for immediate CAS must be specifically cleared by the FSCC of the unit in whose zone of action the fires will impact. The FSCC with

which the DASC is collocated must advise the DASC that the mission is approved or disapproved before final mission processing is completed and control of CAS aircraft is passed to the terminal controller.

Under passive clearance procedures, FSCCs monitor the transmitted CAS request and either remain silent if the request is cleared (*silence is consent*) or interject if the request is not cleared or if more time is required to clear the request. In this case, the DASC processes the mission request unless the FSCC with which the DASC is collocated disapproves the request for immediate CAS. To avoid inadvertent clearance resulting from loss of communications, commanders may modify passive clearance procedures by stipulating that immediate CAS requests are not cleared unless the appropriate FSCCs acknowledge that the request was monitored. For purposes of confirmation or when doubt exists, the DASC will coordinate with the air officer in the FSCC with which the DASC is collocated. Requests for CAS beyond the fire support coordination line (FSCL) need not be cleared, but FSCCs must inform all other affected units (e.g., special operations forces and reconnaissance units) of these missions in sufficient time to allow necessary reaction to avoid friendly casualties. In exceptional circumstances, the inability to do so will not preclude the attack of targets beyond the FSCL by CAS aircraft; however, failure to coordinate these missions increases the risk of friendly casualties and could waste limited resources through duplicative attack. The MAGTF FSCC will establish procedures for exchanging this information with other components of a joint force.

(2) Mission Processing. The DASC begins processing immediate CAS requests on receipt. It completes mission processing upon receiving clearance from the FSCC with which it is collocated. Clearance may be either positive or passive as designated by the commander. After examining assets and priorities and coordinating with the TACC as required, the DASC identifies what aircraft are available for the mission. The aircraft assigned may come from multiple sources, including ground alert aircraft, airborne alert aircraft, or, if required, aircraft diverted from another mission. The aircrew(s) will be provided with the final control data. The DASC keeps the CAS requester informed of the status of the aircraft filling his request. The DASC will assign a request number for the mission. Figure 4-3 on page 4-22 gives an example of a transmission by the DASC informing the terminal controller of the mission status.

(3) Procedural Control. Procedural control of assigned aircraft will be provided by the DASC to a point at which control will be assumed by the terminal controller. The DASC determines aircraft routing in coordination with the senior ground combat element (GCE) FSCC on the basis of the tactical situation and the threat. Aircraft are normally routed by using preestablished control points throughout the area. The terminal controller will provide routing for the aircraft from the point at which initial contact is made with the aircraft.

(4) Initial Contact. Initial contact with the terminal controller will be initiated by the aircraft on the assigned frequency. An example of this initial contact is provided in figure 4-4 on page 4-23.

Transmission:

DASC: "Tiger 14, this is Budworth, mission 10-2, Check, two F/A-18s inbound with Rockeye ETA 15, contact on Orange."

Description of Transmission:

Identification	Tiger 14, this is Budworth
Request number	Mission 10-2
Call sign of flight ¹	Check
Number of aircraft	Two F/A-18s inbound
Type of ordnance	Rockeye
Estimated time of arrival (ETA) in minutes	ETA 15
Frequency of terminal control	Contact on Orange

Legend: ¹The aircraft flight is referred to collectively by call sign; individual aircraft in the flight are referred to as "lead" (flight leader) and "dash (number)" (remaining aircraft in flight), for example, "dash 2."

Figure 4-3. Example of Transmission of Immediate Mission Status to Terminal Controller by Direct Air Support Center.

4008. Brief. The brief provides the aircrew with essential information for execution of the mission. The terminal controller may transmit the brief in one transmission or in bursts of several lines, consistent with the communications security situation. The brief follows a numbered format sequence; therefore, reference to line numbers or elements is not required. The brief should be passed to the aircrew as early as communications can be established. As a last resort, the aircrew can receive the brief at the contact point/holding area. The terminal controller uses a CAS briefing

form. (See figure 4-5 on page 4-24.) Remarks may follow the CAS briefing, as required. Information may be provided on the threat, hazards, weather, ordnance delivery, attack heading, airspace coordination, and so on.

Transmission:	
Flight leader:	"Tiger 14, this is Check 10-2, two F/A-18s inbound Chevy 12 Rockeye ¹ each, 0 + 30."
Terminal controller:	"Roger, Check, proceed to Chevy, stand by for brief."
Flight leader:	"Ready to copy."
Description of Transmission:	
Identification	Tiger 14, this is Check
Mission number	10-2
Number of aircraft and type of ordnance	Two F/A-18s inbound Chevy 12 Rockeye each
Time on station	0 + 30
Legend: ¹ The ordnance may be referred to by a preestablished code, for example, D-22.	

Figure 4-4. Example of Initial Contact Between Aircraft and Terminal Controller.

Example
"Artillery firing in target area . . . remain above 1,000 feet inbound IP."

Transmission:

“Snake 045, left 12.3, 55, five armored vehicles moving north to south in column, SS623 456, WP, south 1,000, egress south to ford.”

Description of Transmission:

IP or battle position	Snake
Heading and offset	045, left
Distance	12.3
Target elevation	55
Target description	Five armored vehicles moving north to south in column
Target location	SS623 456
Type of mark (if beacon or laser, include appropriate code) ¹	WP
Location of friendly forces ¹	South 1,000
Egress ¹	Egress south to ford

Legend: ¹These elements may be omitted in a limited communications environment.

Figure 4-5. Example of Close Air Support Briefing.

4009. Time. Immediately following the brief, the terminal controller gives the aircrew the desired time for ordnance to impact on the target. If both the terminal controller and aircrew are on a synchronized clock, this time should be expressed as a TOT. Using TOT eliminates the need for a hack and eases coordination of target marking and SEAD. TOT and synchronized clock are described in appendix D.

Example

Terminal controller: "Time on target 30."

Flight leader: "Roger, 30."

If a synchronized clock has not been established or is not maintained by either the terminal controller or flight leader, TTT may be used to coordinate the timing of the mission. TTT is the number of minutes and seconds to elapse before the ordnance impact on the target. The TTT is followed by the word "hack." The TTT must allow sufficient time for the aircrew's response and flight time. Generally, a TTT of six to eight minutes is used. The aircrew must determine whether they can comply with the desired TTT. The terminal controller passes the TTT to the aircraft as shown in the following example.

Example

Terminal controller: "Six plus zero, zero . . . hack."

When the flight leader reads back the hack time, this indicates that he has a good copy of the brief, that the hack was accomplished, and that the hack allows sufficient time for the aircraft's response. If the time is too short, he transmits "negative" and states a required TTT to allow aircraft positioning for ordnance delivery. The countdown continues from the original hack.

Example

"Negative, eight plus zero, zero."

The terminal controller then reexamines the situation and determines whether the required TTT indicated by the pilot is acceptable. If it is acceptable, the terminal controller restates the TTT to the flight leader.

Example

“Eight plus zero, zero.”

If the flight leader fails to copy all of the brief but can comply with the hack, he notifies the terminal controller and indicates the specific line(s) of the brief that he failed to copy. He also acknowledges the hack. The countdown continues from the hack.

Example

Flight leader: “Tiger 14, Check 10-2, say again line two, roger, six plus zero, zero.”

Terminal controller: “045, left.”

If the flight leader missed parts of the brief and missed the hack, then the transmissions are made as shown in the following example.

Example

Flight leader: “Tiger 14, Check 10-2, say again line two, negative hack.”

Terminal controller: “045, left, six plus zero, zero . . . hack.”

Flight leader: “Roger, six plus zero, zero.”

At the end of the mission brief, the flight leader repeats the TOT/TTT to notify the terminal controller that the flight leader received and understood the entire mission brief.

4010. Mark, Adjustment, and Control of Initial Aircraft. A laser, infrared, or munitions mark may be required to assist aircraft in identifying the target. The preferred method of marking a target is by laser if the aircraft has a laser seeker or airborne passive laser spot tracker. A WP munitions mark, if required, will be timed to impact 20 to 30 seconds before the established TOT or TTT; an illumination mark (fuzed to burn on the ground) should impact 45 seconds before the TOT/TTT. If the attacking aircraft is in a low-level approach, it will start to climb at a pullup point to gain sufficient height from which to observe the mark and execute the attack. The pilot will establish the pullup point somewhere between the IP and the target. Positive clearance from the terminal controller for the aircraft to drop/fire is normally required before delivery of any ordnance. Before clearing the aircraft, the terminal controller should have both the aircraft and target in sight and ensure that the aircraft's wings are level and pointed in the correct direction. (See paragraph 4013.)

a. Laser Mark. A laser mark is the most effective means of improving accuracy of aircraft-delivered ordnance. The combination of a laser mark and laser-guided weapons (LGWs) provides the best results. If the aircraft is equipped with a laser spot tracker, the pilot can also employ a laser mark to visually locate the target and to conduct an accurate attack with unguided ordnance. In a preplanned mission, the laser-on time may be specified in the

JTAR, in which case the terminal controller turns the laser on and off as scheduled. The pilot will normally initiate laser on in immediate and on-call missions. This is done by transmitting a “10 seconds” warning call that the aircraft will need laser on in 10 seconds, and then “laser on” when ready to acquire the laser. Pilots may also use this technique to initiate laser on in preplanned missions. Normal laser designation time is 20 seconds, although pilots may request longer laser-on time by specifying a time after transmitting “laser on,” for example, “laser on, 30 seconds.” If communications are unreliable, the terminal controller should begin designating 30 seconds before TOT or TTT. When the terminal controller turns on the laser, he alerts the pilot and, if the aircraft’s wings are level and pointed in the right direction, clears the pilot to attack by saying “cleared hot.” The pilot confirms that he sees the designated laser spot by transmitting “spot” and acknowledges the clearance by repeating “cleared hot.” Minimizing laser-on time is important in a laser countermeasures environment and when employing battery-operated laser designators. The terminal controller will turn off the laser designator when the pilot transmits “terminate,” when the weapon hits the targets, or after 20 seconds of laser designating (or longer if specifically requested or if communications are unreliable).

Example

Flight leader: "10 seconds." (no response required)

Flight leader: "Laser on, 30 seconds." (Terminal controller may elect to turn the laser on 10 seconds after the 10-second call without hearing the laser-on call if communications problems are expected. Flight leader may request longer laser-on time.)

Terminal controller: "Laser on, 10-2, (aircraft is wings level, on heading, and pointed at the target), cleared hot."

Flight leader: "Spot, 10-2, roger, cleared hot."

Flight leader: "Terminate."

Offset designation procedures may also be used in a laser countermeasures environment and, if required, will be indicated by the terminal controller in the remarks section of the CAS briefing. At the laser-on call, the terminal controller will designate an offset position near the target to avoid alerting the target. The pilot will then transmit "shift" to direct the terminal controller to shift laser energy from the offset position onto the target itself. The "shift" transmission, when used, can replace the "spot" transmission. (Refer to chapter 9 and Joint Pub 3-09.1, *Joint Laser Designation Procedures*, for more information on laser operations.)

b. Infrared Mark. Infrared pointers and other infrared devices that can assist a terminal controller in marking a target at night are now becoming available. Although these infrared devices can be very effective in identifying targets to pilots who are wearing night vision devices, they cannot be used to guide or improve the accuracy of aircraft ordnance. These infrared devices should be used only in situations where the enemy is unlikely to also have night vision devices. Infrared marks should be initiated 20 to 30

seconds before the TOT/TTT or when requested by the pilot and should continue until the pilot transmits “terminate” or the weapon hits the target.

Example

Flight leader: “Sparkle on.” (Terminal controller may elect to turn infrared pointer on 30 seconds before the TOT/TTT without hearing the sparkle-on call if communications problems are expected.)

Terminal controller: “Sparkle on, 10-2, (aircraft is wings level, on heading, and pointed at the target), cleared hot.”

Flight leader: “Spot, 10-2, roger, cleared hot.”

Flight leader: “Terminate.”

c. Munitions Marking. Marking with artillery, NGF, or mortar fires is an effective means of assisting pilots in visually acquiring the target, but, unlike laser marks, these means do not improve the accuracy of aircraft ordnance. (See chapter 8 for artillery, NGF, and mortar procedures to provide a mark for CAS aircrews). Before choosing to mark by artillery, NGF, or mortars, observers should consider the following:

- The ability of these munitions by themselves to achieve the desired effects on the target
- The prudence of diverting these supporting arms from other missions
- The danger of additional exposure of these supporting arms to the enemy’s indirect-fire acquisition devices

- The additional coordination between supporting arms required for this mission.

If the decision is made to mark the target with another supporting arm, WP marking rounds will be timed to impact 20 to 30 seconds before the established TOT or TTT; illumination marks (fuzed to burn on the ground) should impact 45 seconds before the established TOT or TTT. When marking rounds appear, the terminal controller transmits an adjustment and, if the aircraft's wings are level and pointed in the right direction, clears the aircraft to attack. An adjustment orients the pilot's eyes in the vicinity of the target. Speed in adjustment is more important than accuracy because this gives the pilot more time to identify the target. The terminal controller makes the adjustment by using a cardinal direction and distance (in meters) from the marking round to the target. The terminal controller may need to specify the marking round to help the pilot differentiate it from other munitions exploding in the battlespace, for example, "from the mark WP, west 200." If there is a prominent ground reference available, the terminal controller can use it in the adjustment, for example, "from the mark, west 200 in ravine." The pilot acknowledges the adjustment by transmitting "tally mark" and the clearance by transmitting "cleared hot." (See figure 4-6 on page 4-32.)

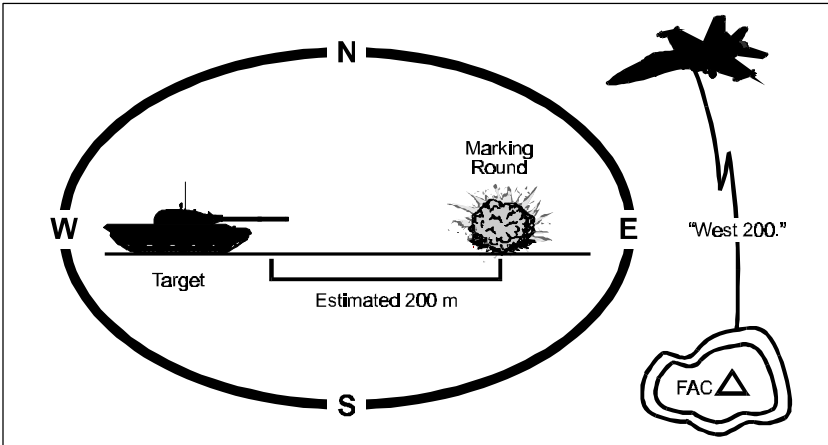

Figure 4-6. Adjustment From Marking Round.

Example

Terminal controller: "10-2, from the mark, west 200, (aircraft is wings level, on heading, and pointed at the target), cleared hot."

Flight leader: "Tally mark, roger, (aircraft is wings level, on heading, and pointed at the target), cleared hot."

The following applies should the pilot need help identifying the mark.

Terminal controller: "10-2, from the mark, illumination on deck, west 200, (aircraft is wings level, on heading, and pointed at the target), cleared hot."

Flight leader: "Tally mark, roger, (aircraft is wings level, on heading, and pointed at the target), cleared hot."

The following applies if a prominent ground reference is available.

Terminal controller: "10-2, from the mark, west 200 on north side of dirt road, (aircraft is wings level, on heading, and pointed at the target), cleared hot."

Flight leader: "Tally mark, roger, (aircraft is wings level, on heading, and

d. Abort Procedures. If it is necessary to discontinue an aircraft's run on a target, the terminal controller does so by transmitting "abort, abort, abort."

4011. Adjustment and Control of Subsequent Aircraft. When the flight consists of multiple aircraft, each aircraft may be individually adjusted onto the target. Subsequent aircraft normally trail preceding aircraft by approximately 30 seconds. This lapse allows protection of aircraft from fragmentation. The adjustment for subsequent aircraft is made from the preceding aircraft's hit or from the impact of the marking round (whichever is closer to the target) by using the same procedure (cardinal direction and distance). (See figure 4-7 on page 4-34.) The terminal controller

provides clearance to attack in the same manner for subsequent aircraft as for the lead aircraft.

Example

Terminal controller: "From lead's hit, east 200, cleared hot."

Wingman: "Roger, cleared hot."

The following example applies if the mark is closer than the lead's hit.

Terminal controller: "From the mark, west 200, cleared hot."

Wingman: "Tally mark, roger, cleared hot."

4012. Reattacks. As a general rule, a goal of CAS is to complete a successful attack against all targets on the first pass. In a low or medium threat, reattacks may be a viable option. The reattack should ensure the desired effect on the target, allow visual orientation by the pilot, and increase responsiveness to the ground commander. If a reattack is conducted, the terminal controller will give the pilot a pulloff direction and may assign different attack headings. Additional marks or a narrative description of target location in relation to the last mark, last hit, landmarks, terrain features, or friendly positions may be given. The aircraft may also be returned to the IP for reattack.

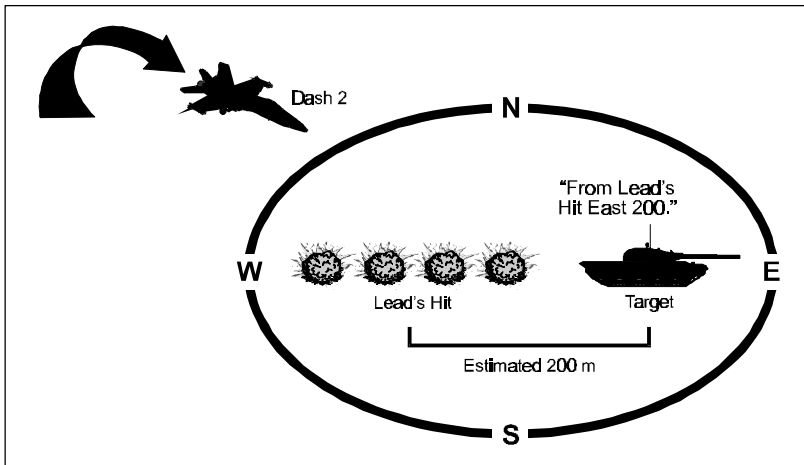

Figure 4-7. Adjustment for Dash 2.

4013. Reasonable Assurance. Aircrews must receive positive clearance (“cleared hot”) from the terminal controller before releasing any ordnance. During peacetime training/exercises, personnel involved in CAS missions must follow range training regulations for release of ordnance. During combat operations, battlespace conditions (communications jamming, low-altitude flight, etc.) can prevent the terminal controller from being able to positively clear aircraft to deliver ordnance. In such cases, aircrews and supported units may have to rely on the concept of reasonable assurance to complete the mission. Reasonable assurance allows aircrews to deliver their ordnance without verbal clearance if they are *reasonably* sure that they are attacking the proper target. The MAGTF commander normally establishes the precise guidelines and procedures for the use of reasonable assurance and disseminates

them throughout the MAGTF and supporting carrier wings. Examples of reasonable assurance guidelines and procedures include the following:

- The MAGTF commander declares that reasonable assurance is acceptable for CAS missions under night or limited-visibility conditions when the terminal controller's laser spot or munitions mark can be positively identified by the pilot.
- The MAGTF commander declares that reasonable assurance is acceptable for day visual attack when the pilot verbally acknowledges the CAS brief.

4014. The Report. Following completion of the attack, a report giving bomb damage assessment is provided by the terminal controller. The report may be transmitted to the pilot, if still within communications range, or to the DASC. (See figure 4-8 on page 4-36 for an example of a transmission of a report and a description of the transmission.)

Transmission:

"SS619 456, 0905, 0906, 75 over 80, four armored vehicles destroyed, one turning east, 10 killed in action (KIAs), mission successful, T6G."

Description of Transmission:

Target coordinates (location of target when attacked) SS619 456

Time on/off target (time of aircraft attack/time aircraft completed mission and departed)	0905, 0906
Percent ordnance on target/percent target destroyed	75 over 80
Results	Four armored vehicles destroyed, one turning east, 10 KIAs, mission successful
Unit supported by the mission	T6G

Figure 4-8. Example of Report on Immediate Close Air Support Mission.

4015. Air-Delivered Ordnance in Vicinity of Friendly Troops.

The accuracy of air-delivered ordnance is subject to many variables. Therefore, unlike for indirect-fire weapons, a danger close distance for the safe separation of air-delivered ordnance is difficult to establish. When air-delivered ordnance is to be delivered near friendly forces (danger close), a careful analysis must be made. The air control agency must consider the situation when selecting and assigning aircraft. Once assigned, the pilot must incorporate this situation into the selection of his attack tactics. Finally, the terminal controller must provide data/instructions to assist the pilot in ensuring safe separation. As with all CAS missions, the supported commander must approve its delivery. Factors that may be considered when delivering air-delivered ordnance in the vicinity of friendly troops include the following.

a. Type and Size of Ordnance. The accuracy of air-delivered ordnance varies with the type, size, and method of delivery of the ordnance; the type of aircraft; and the pilot's proficiency.

b. Aircraft Type/Weapons System/Attack Tactics. The accuracy of air-delivered ordnance varies with the type of aircraft and weapons systems being employed. Sophisticated weapons enhance delivery accuracy and reliability. Generally, high-angle delivery enhances accuracy.

c. Attack Heading. The most common inaccuracies in delivering ordnance occur in low dive angles, which result in errors in range along the attack heading of the aircraft. Therefore, in proximity to friendly forces, an attack heading that is parallel to friendly troops enhances safety and is much preferred.

d. Weather in the Target Area. Low ceiling restricts aircraft tactics and acquisition of the target.

e. Terrain in the Target Area. The position of the target on terrain features (e.g., in a draw or on a hill) will influence the aircraft's attack tactics and, therefore, accuracy.

f. Threat. The threat level and type of threat influence attack tactics. In a high threat environment, low-level, high-speed tactics may reduce accuracy. The characteristics of the threat weapons (e.g., range, method of acquisition, etc.) will influence tactics as well.

g. Availability and Visibility of Target/Marking. The availability of a mark and its acquisition by the pilot enhance the safe delivery of air-delivered ordnance.

h. Terminal Controller Proficiency. The availability of an experienced FAC and his ability to control the airstrike will enhance the safe delivery of ordnance. The ability to control depends on the terminal controller's ability to see the target, the mark, and the aircraft during its attack, as well as on communications.

i. Type and Degree of Friendly Cover

4016. Emergency Procedures for Requesting Close Air Support. In an emergency situation during combat, a need may exist for an untrained Marine to request and adjust CAS. After the requester identifies himself, he specifies where, when, and on what he desires CAS and whether he can control the delivery. (See figure 4-9 on page 4-39.)

Transmission:

"I have five armored vehicles moving in column on road. Coordinates SS623 456, elevation 55. Need support ASAP. I *cannot* control."

Description of Transmission:

What (target description)	I have five armored vehicles moving in column on road.
Where (target location)	Coordinates SS623 456, elevation 55.
When (time airstrike is required: ASAP, NLT, at specific time)	Need support ASAP.
Whether (statement of whether the requester can control, observe, mark, correct)	I <i>cannot</i> control.

Figure 4-9. Example of Emergency Transmission of a Request for Close Air Support.

(reverse blank)

Chapter 5

Artillery and Mortar Special Situations

Section I. Artillery and Mortar High-Angle Fire

High-angle fire is “fire delivered at angles of elevation greater than the elevation that corresponds to the maximum range of the gun and ammunition concerned; fire, the range of which decreases as the angle of elevation is increased.” (Joint Pub 1-02) High-angle fire is employed for artillery when the weapons fire out of defilade, from within built-up areas, or over high terrain features near friendly troops. It is also employed against targets in defilade when the target is directly behind hill crests, in jungles, or in deep gullies or ravines and cannot be reached by low-angle fire. All U.S. artillery weapons are capable of high-angle fire. Mortars are used to conduct only high-angle fire.

5101. Procedures. The FO procedures for the adjustment of high-angle fire are the same as those for the adjustment of low-angle fire. The FO must realize that small deviation corrections during adjustment may be unnecessary and time consuming because of the increased dispersion experienced during high-angle fire. Because the TOF is long in both adjustment and fire for effect, the FDC announces “shot” when the round is fired and announces “splash” five seconds before the burst occurs. Fuze time is not used in high-angle fire. If an air burst is desired, fuze VT provides excellent results.

Section II. Artillery and Mortar Precision Fire

The use of precision fire places a great deal of responsibility on the observer. The FO must consider the time required, ammunition expenditure, and signature of the firing unit in relation to the effect to be gained from precision fire missions. There are two types of precision missions: registration and destruction. When conducting precision fire, an eight-digit grid should be used unless the FO is equipped with a laser rangefinder.

5201. Artillery Registration Missions. Registration is “the adjustment of fire to determine firing data corrections.” (Joint Pub 1-02) The FO is directed to conduct registrations when the firing unit has no other means to determine firing data corrections to improve its accuracy. The following types of registration will be discussed: precision registration of artillery using fuze quick and fuze time, second-lot registration, abbreviated registration, and precision registration for mortars.

a. Precision Registration. A precision registration is conducted with a single weapon. The FDO may instruct the FO to conduct a registration on a designated point or may have the FO select the registration point. The registration point should be accurately located, semipermanent, near the center of the zone, on fairly level terrain if possible, and on common survey with the firing unit. The registration may include an impact portion (adjustment of fuze quick) or an impact and time portion (adjustment of fuze quick and fuze time). The precision registration is initiated with an MTO.

Example

FDC: "H18 this is H44, register on known point 2, quick and time, over."

FO: (Read back by observer.)

FO: "Direction 6400, over." (Transmission given when ready to observe.)

FDC: (Read back by FDC.)

FDC: "Shot, over."

FO: "Shot, out."

The FDC may provide a general vicinity for the observer to select a registration point. In this case, the FO transmits the selected grid (eight-place grid) with altitude and the direction.

Example

"Grid 6124 3843, altitude 210, direction 6310, over."

(1) Impact Portion (Adjustment of Fuze Quick). The objective of the impact portion of a registration is to obtain *spottings* of two overs and two shorts along the OTL from rounds fired with the same data or from rounds fired with data 25 meters apart (50 meters when probable error in range is greater than or equal to 25 meters). These rounds are called usable rounds. This normally requires spottings from four separate rounds. However, a "target hit" or a round that is spotted as "range correct" counts as a spotting of both over and short. Therefore, the objective could be achieved with two consecutive target hits or range correct spottings. The following additional procedures apply.

(a) Deviation. The FO spots the rounds for deviation to the nearest mil and brings rounds onto the OTL before splitting a 200-meter

bracket. Deviation corrections should not be made after a 200-meter bracket has been established. Once the FO brings the rounds onto the OTL, he measures and records deviation spottings but makes no correction. When a doubtful range spotting is obtained, the FO corrects for deviation only. If a deviation correction must be made after a 200-meter bracket has been established, the last round fired and all previous rounds cannot be considered usable rounds for determining range and deviation refinement data.

(b) Range. The FO spots the rounds for range (over, short, or range correct) and makes range corrections by using successive bracketing until a 50-meter range bracket is established (add or drop 50). Once this round impacts, the FO makes his spotting, makes a range correction to fire two rounds with data 25 meters in the direction opposite that of the spotting, and sends “two rounds, add or drop 25.” If both rounds result in spottings of “short” (or “over”), the FO changes the volume to one round and sends “add 25” (or “drop 25”). Firing is continued until two definite range spottings have been obtained at the opposite end of the 25-meter bracket.

(c) Refinement. When the requirement of two overs and two shorts with the same data or data fired 25 meters apart has been met, the impact portion of the registration ends with necessary refinement data. Refinement data may include a deviation correction, a range correction, or both to the nearest 10 meters.

When determining refinement data for range, the location of the registration point is determined with respect to the two sets of spottings and then refinement data is determined and announced. If the registration point is nearer to the last round(s) fired, then *no range refinement* is necessary to move the impact toward the registration point. (See figure 5-1.)

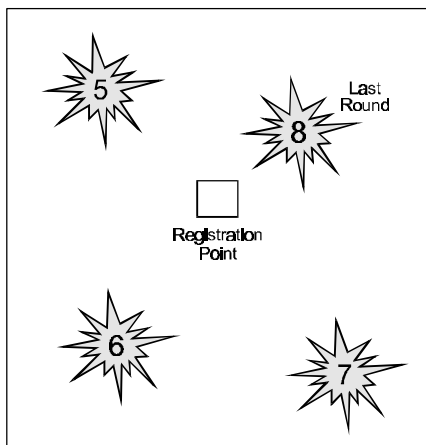

Figure 5-1. No Range Refinement Necessary.

If the registration point is equidistant between the two sets of rounds, then the observer determines the range refinement to be “add 10” or “drop 10” from the last data fired. (See figure 5-2 on page 5-6.)

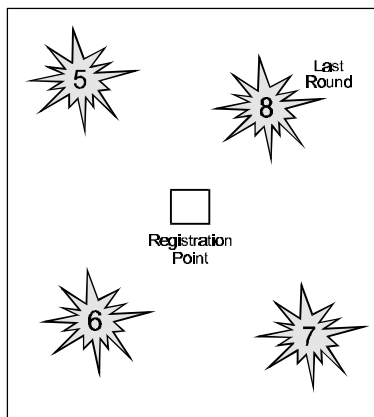

Figure 5-2. Drop 10.

If the registration point is nearer to the pair of rounds at the opposite end of the bracket, then the observer determines the range refinement to be “add 20” or “drop 20” from the last data fired. (See figure 5-3.)

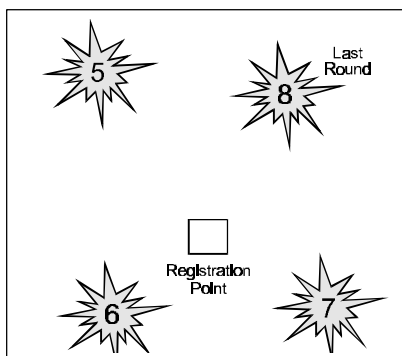

Figure 5-3. Drop 20.

The FO must keep track of the rounds and how they are spotted in relation to the registration point. This is easily done by drawing a registration diagram and numbering the rounds, as illustrated in figure 5-4.

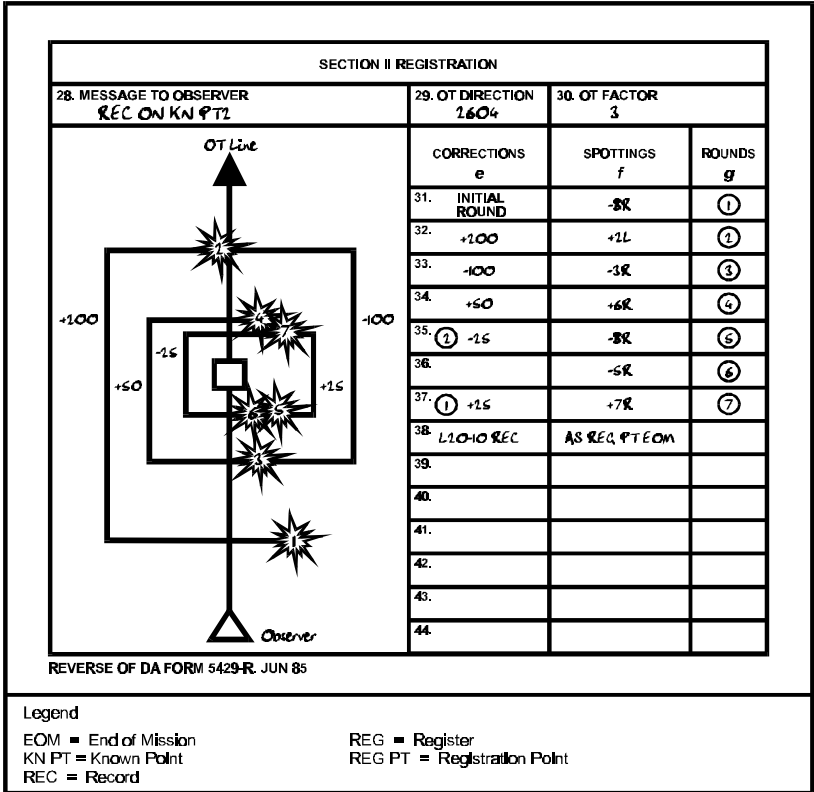

Figure 5-4. Example of Registration Diagram.

Deviation refinement is determined by adding the deviation spottings of the rounds establishing the two overs and two shorts. This may include two, three, or four deviation spottings. This total is then divided by the number of rounds to get an average deviation, which is expressed to the nearest mil. The average deviation multiplied by the OT factor equals the correction, which is expressed to the nearest 10 meters. Figure 5-5 provides an example of deviation corrections for impact registration.

The FO has determined four usable rounds with the following spottings:	
Round	Spotting
4	Over, 6 right
5	Short, 8 right
6	Short, 5 right
7	Over, 7 right

The FO determines the sum of the deviation spottings to be 26 right (6 right + 8 right + 5 right + 7 right).

The average deviation of 6 right (26 right divided by 4 rounds = 6.5 (6 right)) is multiplied by the OT factor (3) to determine the deviation refinement of "left 20" (6 right x 3 = 18 meters right ("left 20")).

If the spottings include right and left spottings, the observer must algebraically compute the average deviation. For example, 7 right and 3 left equals 4 right. If the calculated deviation refinement is less than 10 meters, it is omitted.

The registration point was *equidistant* between the two sets of rounds, as illustrated in figure 5-2. The observer determines the range refinement to be "drop 10."

The observer transmits the following correction: "Left 20, drop 10, record as registration point, (end of mission or time, repeat)."

Figure 5-5. Example of Deviation Corrections for Impact Registration.

If the MTO specified only an impact portion of the registration, then the FO terminates the impact registration by transmitting his

refinement data followed by the announcement of “record as registration point, end of mission.”

Example

“Left 20, drop 10, record as registration point, end of mission, over.”

If the MTO specified an impact and time portion, then the FO terminates the impact portion and initiates the time portion by transmitting his refinement data followed by the announcement of “record as registration point, time, repeat.”

Example

“Left 20, drop 10, record as registration point, time, repeat, over.”

Note

Because the BCS/backup computer system (BUCS) uses only known points, the FO may be required to transmit “record as known point.” In either case, the FDC will send an MTO assigning a target number to the registration point.

(2) Time Portion (Adjustment of Fuze Time). The objective of the time portion of the precision registration is to correct the mean HOB of four rounds fired with the same data to 20 meters above the registration point.

(a) Adjustment. If the first round is spotted as “graze,” then a correction of “up 40” is given. If the first air burst is extremely high, the observer may send a “down” correction and repeat. Once

5-10

a measurable air burst has been obtained, the command is “three rounds, repeat, over.”

(b) Refinement. When four rounds have been fired with the same data, the registration is ended with the appropriate correction to achieve a 20-meter HOB. When four air bursts are spotted, the HOB is corrected to 20 meters. The mean HOB is determined by adding the four spottings (in mils), dividing by four, expressing the sum to the nearest mil, and then multiplying by the OT factor. This is the same technique used in determining deviation corrections. The sum is then expressed to the nearest five meters, and the appropriate correction is determined to achieve the desired 20-meter HOB.

Example

“Up 10, record as time registration point, end of mission, over.”

For mixed spottings, the following automatic corrections are used:

- Three air bursts and one graze—no correction required
- Two air bursts and two grazes—up 10
- One air burst and three grazes—up 20.

Check rounds may be fired to verify the validity of the time registration; however, they are not necessary.

b. Second-Lot Registration. The FDC may direct the FO to conduct a “two-lot” registration. Second-lot registrations are conducted in a manner similar to that for first-lot (single) registrations. After the first-lot impact registration has been completed, a precision registration for fuze time is conducted, if required. The FDC will announce to the FO “observe second-lot registration” after the FO has recorded the registration of the first lot. The FO must then establish the appropriate range bracket and complete the second-lot registration. The time portion of the registration is not fired with the second lot.

c. Abbreviated Registration. At times, the tactical situation or ammunition constraints may prohibit conducting a full-scale precision registration. Although not as accurate, an abbreviated precision registration can compensate for the effects of nonstandard conditions. (Abbreviated registrations are more accurate and therefore more feasible if the FO is equipped with a laser rangefinder). The FDO makes the decision to conduct an abbreviated registration. For this type of registration, the FO merely shortens the standard procedures of a precision registration.

(1) Impact Portion (Adjustment of Fuze Quick). Normal adjust-fire procedures are followed until a 100-meter bracket is split. The correction sent is “add (or drop) 50.” The burst that is a result of an “add (or drop) 50” is spotted. Minor corrections for both deviation and range to the nearest 10 meters are sent to the FDC, along with the announcement of “record as registration point, (time repeat),” as shown in figure 5-6.

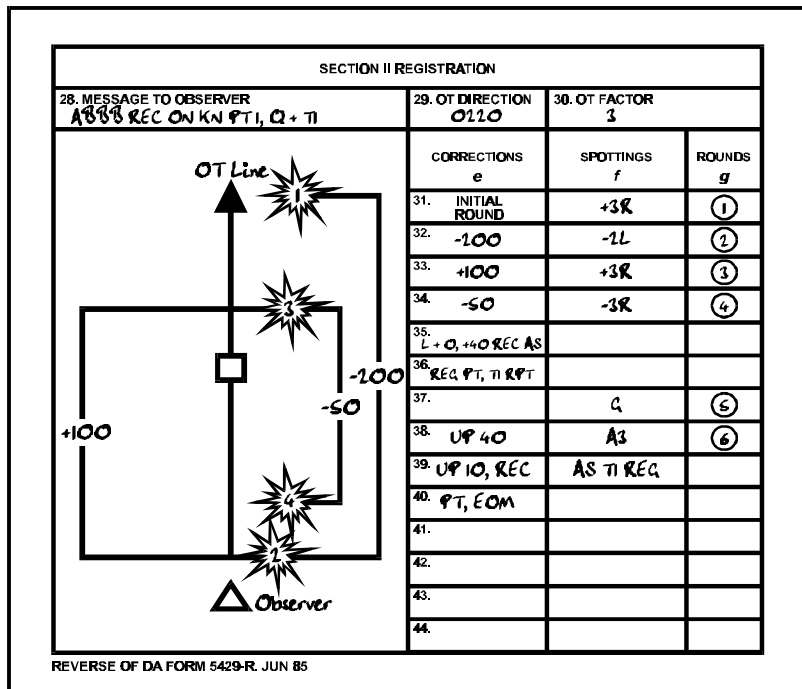

Figure 5-6. Example of Abbreviated Registration.

(2) Time Portion (Adjustment of Fuze Time). Normal adjust-fire time-adjustment procedures are followed in the time portion. An air burst is obtained and then corrected to a 20-meter HOB. Instead of firing for effect, refinement is sent to the FDC, the time registration point is recorded, and the mission is ended.

5202. Precision Registration for Mortars

a. Procedures. Precision registration for mortars is conducted for impact fires only. The procedures are almost identical to the precision registration of fuze quick (impact) procedures for artillery. The exception are as follows:

- Only spottings of one round over and one round short are required.
- Once a 100-meter range bracket has been split and the last fired round is within 50 meters of the target, refinement corrections are sent to the FDC and the mission is ended.
- Range refinements are made to the nearest 25 meters.

The transmissions to the FDC after the last two rounds are similar to those used for artillery.

b. Sheaf Adjustment. The mortar sheaf must be adjusted to make all of the mortars fire parallel. The sheaf may be adjusted at any time during a fire mission but may be directed by the FDC after a registration. The FDC will announce “prepare to adjust sheaf, over.” The mortars will be positioned and numbered in sequence from right to left as seen from behind the tubes. For 81-mm mortars, numbers may be one through eight when positioned as a platoon and one through four for a two-section position.

Note

In the 81-mm mortar platoon, the term “mortar section” refers to four tubes (squads).

5-14

To adjust the sheaf, the observer requests “section right (or left), repeat, over.” Each squad will then fire, in order, from left to right (or right to left) with 10-second intervals between rounds. The mortar that was used to register will not fire.

Example

If the observer requests “section right, repeat, over” and number 2 conducted the registration, then numbers 1, 3, and 4 would fire.

In adjusting the sheaf, all rounds must be adjusted on line at approximately the same range (within 50 meters) and with 40 meters of lateral spread between rounds. Range corrections for rounds impacting within 50 meters of the sheaf line are ignored. The sheaf is adjusted perpendicular to the GTL. If angle T is greater than 500 mils, then each piece is adjusted onto the registration point and the FDC computes data for the sheaf. Lateral refinement corrections are made to the nearest 10 meters, but corrections of less than 50 meters are not fired. Once refinement corrections for all mortars have been determined, the sheaf has been adjusted. For example, the sheaf of an 81-mm mortar platoon is being adjusted where the platoon is employed in two 2-section positions. Tube 2 conducted the registration. The observer has requested “section right, repeat, over.” (See figure 5-7 on page 5-15.)

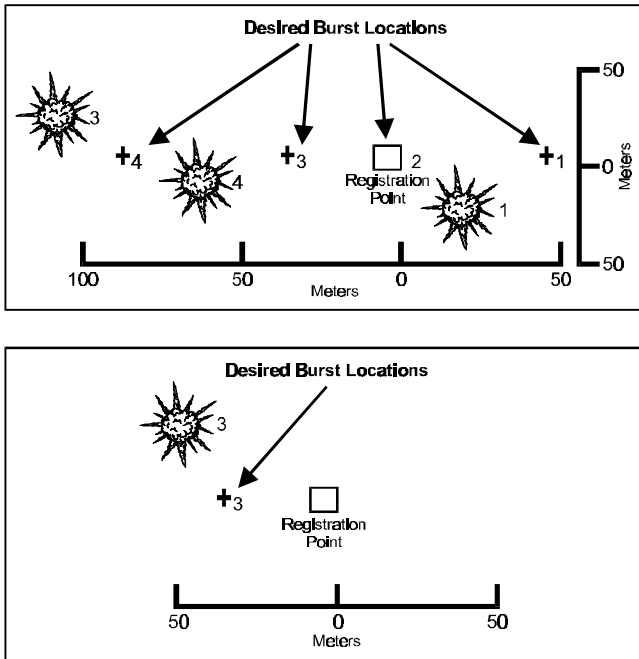

Figure 5-7. Example of the Adjustment of a Mortar Sheaf.

In this example, all rounds are within 50 meters of the correct range. Only number 3 is more than 50 meters out on lateral adjustment, so the adjustment for tube 3 is sent first. Then refinement data for tubes 1 and 4 is sent as follows: “Number 3, right 60, repeat; number 1, right 30, number 1 is adjusted; number 4, left 20, number 4 is adjusted, over.”

Number 3 is now fired, and the round impacts 10 meters right of the desired burst location. The observer transmits “number 3, left

10, number 3 is adjusted, sheaf is adjusted, end of mission, over.” Figure 5-8 shows the adjusted sheaf.

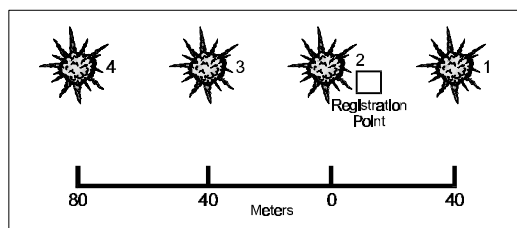

Figure 5-8. Adjusted Mortar Sheaf.

5203. Destruction Missions. Destruction is “a type of adjustment for destroying a given target.” (Joint Pub 1-02) The destruction mission is fired by using one weapon to destroy a point target. The destruction mission is similar to a registration in that the FO continues adjustments to establish a 25-meter bracket by adding or dropping 10 meters. He then continues to fire additional rounds, making corrections to the nearest 10 meters after every third round until the target is destroyed or the mission is ended. After every third round, an additional refinement is made, and firing is continued until the target is destroyed or the mission is ended. Corrections may be made after every round if desired. Because of the amount of time and ammunition required, destruction missions should be used only when required by the tactical situation. Only a target that is critical to an operation should be engaged in this manner, and only if no other means exists to destroy the target, for example, Copperheads. An example of a destruction mission is shown in figure 5-9 on page 5-17.

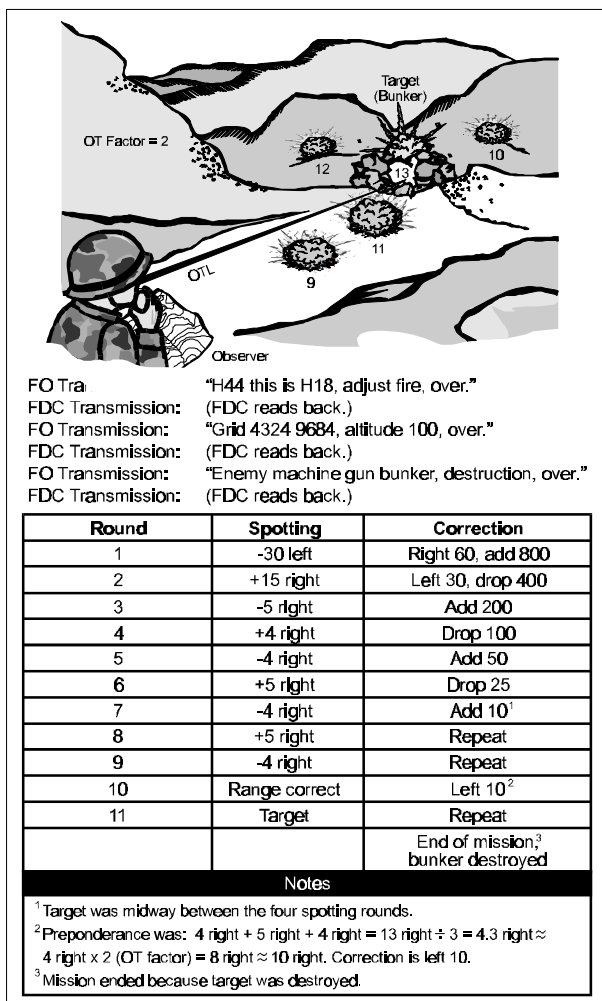

Figure 5-9. Example of Destruction Mission.

Section III. Artillery High-Burst or Mean Point of Impact Registrations

The opportunities for a precision registration are limited because it requires visual observation on a clearly defined, accurately located registration point in the target area. At night, visual adjustment of fire on a registration point is impossible without some type of illumination or night observation device. In desert, jungle, or arctic operations, clearly defined registration points in the target area are not usually available. Special procedures, including observation techniques, have been developed to provide for registration under these conditions. Two such procedures are the high-burst (HB) and MPI registrations.

5301. General. An HB and an MPI registration are identical, except that the rounds for an HB registration are air bursts and the rounds for the MPI registration are impact rounds. Two FOs (referred to as 01 and 02) are required to conduct these registrations. Each FO must occupy a surveyed OP and have a means to accurately conduct angular measurement, such as a BC scope, aiming circle, or MULE. Directional control, or a line of known direction, must be established on the ground so that the FO can orient his instrument for direction. For night observation, this may require the orientation of instruments during daylight. The exact location of the instrument and the line of known direction should be marked so that they can be identified during darkness. Additionally, for HB registration, one FO must be prepared to measure vertical angles.

5302. Procedures for High-Burst Registration

a. Initial Orientation of the Observing Instruments. To prepare the instruments for orientation, the exact location of the instrument and lines of known direction must be known. The instrument (BC scope or aiming circle) is then placed over the position marker and leveled. To orient the instrument, an azimuth of known direction is placed on the azimuth scales using the *upper recording motion*. Then, using the *lower nonrecording motion*, the vertical cross line in the reticle is aligned on the marker or point that identifies the known direction. The instrument is then considered to be properly oriented for direction. If more than one known direction is available, this can be used to check the orientation of the instrument by using the upper motion. Once the instrument is oriented, the lower motion should not be touched. All angular measurements are taken by using the upper motion.

b. Observing the High-Burst/Mean Point of Impact Registration. For the HB registration, the two FOs simultaneously observe time fire aimed at a point in the air above the target area. The FDC selects the point at which the fire is to be aimed by selecting a point on the ground in the area in which the registration is desired and projecting this point into the air with a prescribed HOB. This is the orienting point. The FDC controls the firing of the HB registration. One weapon is used to fire the registration. All rounds are fired with the same data. Each FO reports the direction from his position to the bursts. One of the FOs will be directed to report the vertical angle after each round. For the MPI, the registration is the same, except the rounds are fired with fuze quick.

c. Orientation of the Observing Instruments on the Orienting Point. The FDC orients the FOs by sending an MTO that tells each FO the direction and vertical angle from his position to the selected orienting point.

Example

“Message to observer, observe HB registration, 01 direction 1164, vertical angle plus 12. Measure the vertical angle, 02 direction 0718, vertical angle minus 3. Report when ready to observe.”

Each FO sets the direction given to him on the azimuth scales of his instrument, using the upper motion. In the case of a MULE, the designator is rotated to the correct direction. The horizontal line of sight of the instrument now coincides with the horizontal line of sight from the FO's position to the orienting point. Each FO sets the vertical angle given to him on the elevation scales to orient the instrument for HOB. The manner in which the FO sets the vertical angle on the scales depends on the type of observing instrument being used.

(1) Aiming Circle. The elevation scales on the M2 aiming circle are ideally graduated so that a zero reading on the scales corresponds to a vertical angle of zero. However, a correction factor using the tubular leveling vial must be determined and applied. Refer to MCWP 3-16.3/FM 6-50. The scales are graduated and numbered in each direction from zero. In one direction, the graduations are printed in black; those in the opposite direction are red. Positive (plus) vertical angles are indicated by the black numbers, and negative (minus) vertical angles are indicated by the

red numbers. The elevation scales on the aiming circle are operated with the elevation micrometer knob. The elevation micrometer knob is used to level the tubular leveling vial. The corresponding elevation is the correction factor and is applied to all readings.

Example

Orient to vertical angle +12 with a correction factor of -3; set off vertical angle +15 ($12 - (-3)$).

Orient to vertical angle +12 with a correction factor of +3; set off vertical angle +9 ($12 - (+3)$).

If the vertical angle given to the FO is a positive angle, the FO sets its value on the elevation scales in the direction represented by the black numbers. If the vertical angle is a negative value, he uses the red numbers. This action places the center of the cross lines in the reticle of the instrument in line with the point in the air selected as the orienting point.

(2) Battery Commander Scope. If the FO is using a BC scope, he orients the instrument for HOB by applying the vertical angle to the angle-of-site scales. These scales are graduated so that a vertical angle of zero corresponds to a reading of 300 on the angle-of-site scales. If the vertical angle is positive, its value is added to 300 and the resulting number is set on the angle-of-site scales. If the vertical angle is negative, its value is subtracted from 300 and the remainder is placed on the angle-of-site scales.

Example

The vertical angle is +12; the reading set on the angle-of-site scales is 312
(300 + 12).

The vertical angle is - 3; the reading set on the angle-of-site scales is 297
(300 - 3).

After setting the reading on the angle-of-site scales, the FO levels the angle-of-site mechanism by using the elevation knob to center the bubble in the level vial. This action places the center of the cross lines in the reticle of the instrument in line with the point in the air at which the rounds will be fired.

d. Measuring and Reporting the First Round. When the FOs report “ready to observe,” the FDC directs the firing of the rounds one at a time. The FDC reports “shot” and “splash” for each round. When the burst of the first round appears, each FO determines the direction to the round by spotting the horizontal deviation from the vertical cross line and then combines this value with the reading on the azimuth scales. If the deviation is to the right of the vertical cross line, he adds the value to the reading on the azimuth scales. If the deviation is to the left of the vertical cross line, the FO subtracts the value from the reading on the instrument (RALS). The FOs report their observations in turn.

Example

“01 direction ____, vertical angle ____, over.”

“02 direction ____, over.”

e. Determining the Vertical Angle. The vertical angle to the burst is determined in one of two ways.

(1) Aiming Circle. If using an aiming circle, the FO spots the number of mils that the burst appears above or below the horizontal cross line in the reticle of the instrument and combines this reading with the reading on the elevation scales.

Example

The burst appears 10 mils above the horizontal cross line, and the reading on the elevation scales is +20. The vertical angle to the burst is +30 ($20 + 10$). With a correction factor of +3, the vertical angle is +27 ($30 - (+3)$).

The burst appears 10 mils below the horizontal cross line in the reticle of the instrument, and the reading on the elevation scales is +6. The vertical angle to the burst is -4 ($6 + (-10)$). With a correction factor of -3, the vertical angle is -1 ($-4 - (-3)$).

(2) Battery Commander Scope. If using a BC scope, the FO reads the number of mils that the burst appears above or below the horizontal cross line in the reticle of the instrument and combines this reading with the reading on the angle-of-site scales. The value of the vertical angle is the difference between this combined reading and 300. If the combined reading is greater than 300, the value of the vertical angle is positive. If the combined reading is less than 300, the value of the vertical angle is negative.

Example

The burst appears 20 mils above the horizontal cross line, and the reading on the angle-of-site scales is 305. The vertical angle is +25 ($305 + 20 = 325$; $325 - 300 = +25$).

f. Unobserved Spottings. If the FO does not observe the initial round within the field of view of his instrument, he should report this and the location of the burst to the FDC.

Example

"02 round unobserved, too far left, over."

g. Reorienting on the First Round. Once the FO has reoriented his instrument on the direction and vertical angle where the initial round burst, he will report the direction (and vertical angle if applicable) of the first round to the FDC. (See figure 5-10 on page 5-25.) This will allow for smaller deviation measurements for subsequent rounds.

h. Measuring and Reporting Subsequent Rounds. The procedures for measuring and reporting direction and vertical angle for subsequent rounds are the same as those for the first round. However, the FO typically does *not* reorient his instrument after subsequent rounds. Depending on the proficiency of the observer, he may reorient on each subsequent round. This is most beneficial when the registration point is not affected by strong winds and the observer is equipped with an aiming circle. When the FDC has

obtained enough readings to compute the registration data, it terminates the registration by sending “end of mission” to 01.

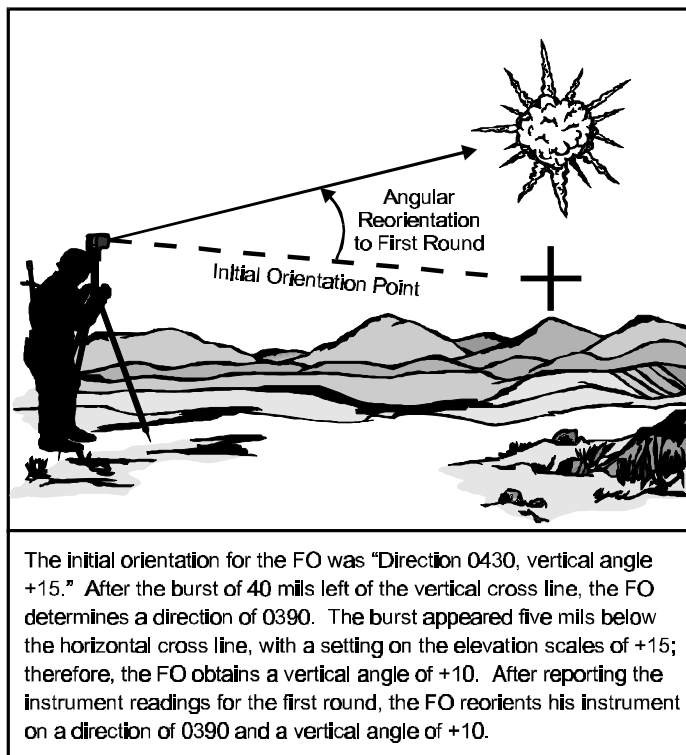

Figure 5-10. Reorientation After the First Round.

5303. Procedures for Mean Point of Impact Registration. In an MPI registration, the FDC selects a ground location as the orienting

point and uses impact fuzes in the registration. The establishment of the OPs and the procedures followed by the FOs are the same as those in an HB registration.

Section IV. Artillery Improved Conventional Munitions

ICMs are HE base-ejection projectiles with a mechanical time fuze and a body assembly containing a number of submunitions. The submunitions (grenades) are ejected through the base of the projectile and scattered in the target area. There are two types of ICM rounds: the antipersonnel round and the dual-purpose round. Table 5-1 shows the number of grenades in each ICM round.

Table 5-1. Number of Grenades in Each Improved Conventional Munitions Round.

ICM	Weapon	Projectile	Number of Grenades
Antipersonnel	105 mm	M444	18
	155 mm	M449 family	60
	105 mm	M915/6	42
Dual purpose	155 mm	M483A1	88
	155 mm	M864	72
	226-mm Multiple Launch Rocket System (MLRS)	M79	644

5401. Antipersonnel Round. The antipersonnel round is most effective against exposed personnel. When the fuze functions, an expelling charge forces the grenades out through the base of the

projectile. Small vanes on each grenade flip forward, arming the grenade and stabilizing it in flight. (See figure 5-11.) When the striker plate (on the base of the grenade) makes contact with the ground, the grenade is hurled upward four to six feet in the air and detonates. Antipersonnel ICM (APICM) is no longer manufactured but is still held in war reserve.

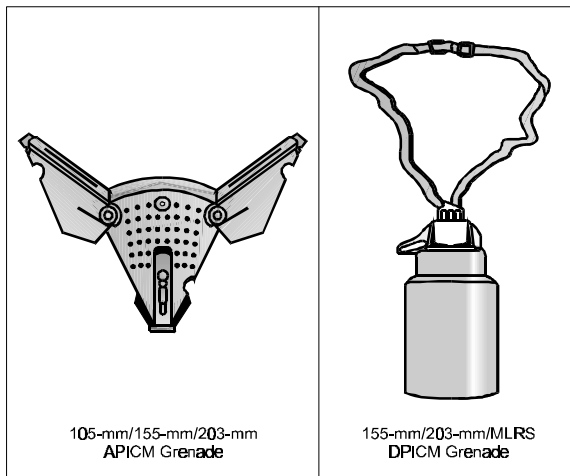

Figure 5-11. Improved Conventional Munitions Grenades.

5402. Dual-Purpose Round. The dual-purpose round is effective against lightly armored or thin-skinned vehicles. However, it is also very effective against personnel. After the grenade is ejected, a ribbon streamer arms and stabilizes it during its descent. (See figure 5-11.) On impact, a shaped charge that can pierce 2.75 inches of

rolled steel armor is detonated. The surrounding steel case fragments are very effective against personnel.

5403. Dispersion. All ICM projectiles are base ejecting. The fuze functions at varying HOBs, and an expelling charge is detonated that ejects the entire payload of submunitions out the rear of the projectile. Centrifugal force disperses the grenades radially from the projectile line of flight. The size and shape of bomblet dispersion patterns are not constant and change over range. Also, the concentration of bomblets is not uniform over the entire surface area. There is a noticeable decrease of submunitions in the center of the dispersion pattern; this is sometimes referred to as the doughnut effect.

a. Antipersonnel Improved Conventional Munitions. M449 APICM dispersion is generally elliptical in shape. It disperses its submunitions approximately 100 meters by 60 meters. Depending on the observer's orientation to the GTL, he could see a varying distribution of submunitions.

b. Dual-Purpose Improved Conventional Munitions. M483A1 DPICM dispersion generally changes shape from elliptical at minimum ranges and lower charges to almost circular at maximum ranges. This variation is due primarily to angle of fall and HOB. At minimum ranges, the dimensions are approximately 50 meters by 100 meters. At maximum ranges, they are approximately 100 meters by 120 meters. Unless the observer is close to the GTL at minimum ranges, he should see bomblet dispersion of approximately 100 meters per projectile.

c. Base Burn Dual-Purpose Improved Conventional Munitions. M864 base burn DPICM (BBDPICM) is currently held in war reserves. Despite having fewer grenades, its dispersion pattern is larger than that of DPICM. However, because it is designed for employment at higher ranges, which produce a steep angle of fall, the dispersion pattern is typically circular. At its designed ranges, the dimensions are approximately 150 meters by 150 meters.

d. Battery Computer System Special Circular Sheaf. Based on the dimensions of a single projectile's dispersion, the dimensions of the typical sheaf can be predicted. The default BCS special circular sheaf is a 100-meter radius with aim points equally distributed on a concentric circle at half the target radius (50 meters). Depending on the range, the DPICM sheaf is typically 200 meters by 200 meters. Figure 5-12 on page 5-30 shows four guns firing DPICM at maximum range and at shorter ranges. Angle T can affect what the observer sees regarding the sheaf. The BBDPICM sheaf is consistently 250 meters by 250 meters. Figure 5-13 on page 5-30 shows four guns firing BBDPICM. Note that errors as a result of the dispersion of the projectiles can cause a random gap or overlap within the sheaf.

5404. Improved Conventional Munitions Call for Fire and Adjustment. The ICM call for fire is the same as any call for fire. (See figure 5-14 on page 5-31.) The FO identifies the type of ICM that he wants to be fired in effect by referring to APICM as APICM and DPICM as ICM. BBDPICM is only employed at ranges beyond DPICM, as determined by the FDC. (See appendix F.) Normal corrections for HE in adjustment apply; however, the fire-for-effect

phase is entered once a 200-meter bracket is established. Procedures for the adjustment of the ICM follow.

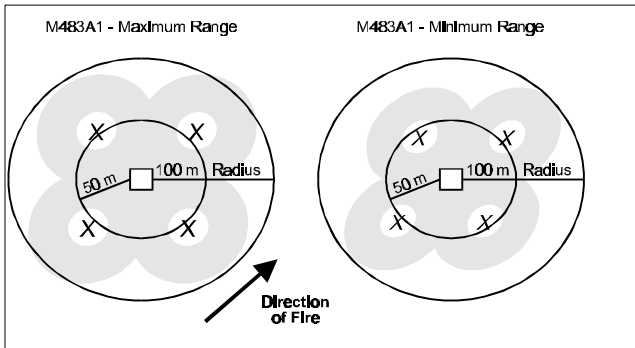

Figure 5-12. M483A1 Dispersion Pattern at Maximum and Minimum Ranges.

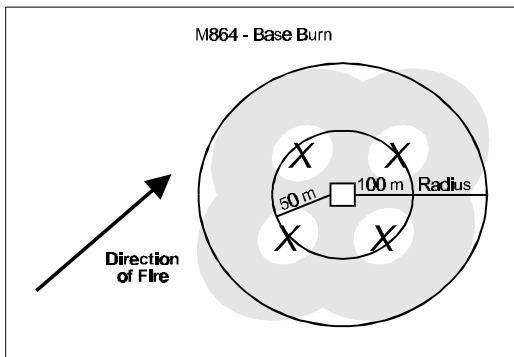

Figure 5-13. M864 Base Burn Dispersion Pattern.

<p style="text-align: center;">HE Adjustment—DPICM in Effect</p> <p>“P51 this is P87, adjust fire, over.” “Grid 933 876, over.” “Infantry company halted, APICM in effect, over.”</p> <p style="text-align: center;">Fire for Effect With DPICM</p> <p>“P51 this is P87, fire for effect, over.” “Grid 372 461, over.” “Platoon assembly area, ICM, over.”</p>
--

Figure 5-14. Example of Improved Conventional Munitions Missions.

a. Range and Deviation. Because of the size of the effects pattern, deviation shifts of less than 50 meters and range corrections of less than 100 meters should not be made. Normal range and deviation corrections are used when adjusting DPICM in the self-registering mode.

b. Height of Burst. Because of the reliability of the round, no adjustment for HOB is required before firing for effect. However, errors in either target location or firing solution can produce effects other than the designed HOB. The result is bomblet dispersion that is either too large to be effective or too small to adequately cover the target area. If a repeat of fire for effect is required, HOB may then be adjusted. The observer corrects the HOB up to increase dispersion and corrects it down to decrease dispersion. Corrections are made in 50-meter increments.

c. Danger Close. When adjusting close-in fires with ICM, the observer must start the adjustment at least 600 meters from friendly

troops, depending on the relative locations of weapons, the target, and friendly troops. Special consideration must be given to the direction and speed of the wind in the target area. The adjustment should be made with the entire battery. Corrections should be made from the near edge of the effects pattern. Use of a converged sheaf should be considered to decrease the size of the sheaf.

5405. Employment Considerations. ICM should not be fired into wooded areas. The grenades become suspended in tree branches and later pose a threat to friendly forces. Discretion should be exercised when using ICM in an area that friendly forces must cross because the unexploded submunition rate is approximately 1.5 percent. Precautions should be taken when firing ICM rounds in snow, marshy areas, and loose sand. These types of terrain conditions do not increase the dud rate but do pose more of a threat to friendly forces by concealing duds. Slopes of more than 60 degrees reduce the effectiveness of ICM. Because of the large area covered, limited use is recommended close to unprotected friendly troops.

Section V. Artillery Family of Scatterable Mines

FASCAM are time-sensitive, self-destructing mines that are emplaced by different assets, including aviation. Artillery FASCAM consists of antiarmor and antipersonnel mines in a base-ejecting projectile. These FASCAM projectiles consist of the remote antiarmor mine system (RAAMS) and area denial artillery munitions (ADAM).

5501. Remote Antiarmor Mine System Projectiles. RAAMS minefields are used against enemy armored vehicles. The RAAMS projectile is fired by a 155-mm howitzer, and nine antiarmor mines are base ejected over the target area. After a short delay to allow for mine freefall, impact, and roll, the magnetically fuzed mines arm themselves. Some of the mines have an antidisturbance feature that causes the mines to detonate if they are moved or picked up. If the RAAMS mines are not detonated, they will begin to self-destruct after 80 percent of the factory-set self-destruct time elapses.

a. M718 Projectile. The M718 projectile has a long-duration factory-set self-destruct time (48 hours).

b. M741 Projectile. The M741 projectile has a short-duration factory-set self-destruct time (four hours).

5502. Area Denial Artillery Munitions Projectiles. ADAM mines are used against personnel. They can be used against dismounted personnel in an armored attack or on existing antitank obstacles to hinder dismounted breaching. When employed against an enemy that has a dismounted breaching capability, ADAM mines are delivered directly on top of a RAAMS minefield. ADAM rounds are always the last rounds fired when used in conjunction with RAAMS or other munitions. This prevents the activation or destruction of the ADAM munitions by the other means.

The ADAM projectile is fired by a 155-mm howitzer, and 36 antipersonnel mines are base ejected over the target area. When an ADAM mine comes to rest on the ground, several tripwire sensors

are deployed out to a maximum distance of 20 feet. When a sensor is disturbed or tripped, a small ball-like munition is propelled two to eight feet upward. The munition detonates and scatters approximately 600 1.5-grain steel fragments in all directions. If the mine tripwire sensors are not disturbed, the mine will self-destruct after the factory-set time has elapsed.

a. M692 Projectiles. The M692 projectile has a long-duration factory-set self-destruct time (48 hours).

b. M731 Projectiles. The M731 projectile has a short-duration factory-set self-destruct time (four hours).

5503. Types of Minefields. Three types of RAAMS/ADAM minefields may be used, depending on the amount of planning and coordination time available and the density of the mines. The three types are planned minefields, target-of-opportunity minefields, and minefields used with other munitions.

a. Planned Minefields. These minefields are normally initiated and coordinated at the higher level. They are scheduled or on-call targets to support barrier/obstacle plans. They consist of long or short self-destruct mines. Safety zones are computed before firing.

b. Target-of-Opportunity Minefields. These minefields are initiated through the call for fire and support the maneuver commander with an immediate minefield. They consist of only short self-destruct mines. The standard minefield module is 400 meters by 400 meters. Target-of-opportunity minefields are normally low density with a combination of RAAMS and ADAM projectiles. The

number of projectiles varies depending on the range, angle of fire, and minefield attitude. The safety zone is based on aim points and is computed immediately after firing. The safety zone contains 99 percent of the deployed mines and represents the effective friendly obstacle for maneuver elements.

c. Minefields Used With Other Munitions. Minefields established in conjunction with an attack using other munitions are initiated through the target list or the call for fire. They support operations by harassing enemy targets within constraints set by the supported commander. These minefields are sized on the basis of the method of attack and use of RAAMS, ADAM, or a combination in the last volley. They consist of only short-duration mines. The safety zone is computed immediately after firing.

5504. Target Location

a. Moving Targets. The aim point for a moving target is placed directly in front of the enemy axis of advance. An aim point is placed 1,000 meters in front of the enemy target for every 10 kilometers per hour of speed, as shown in figure 5-15 on page 5-36. This allows enough time for mine delivery and arming before an enemy encounter.

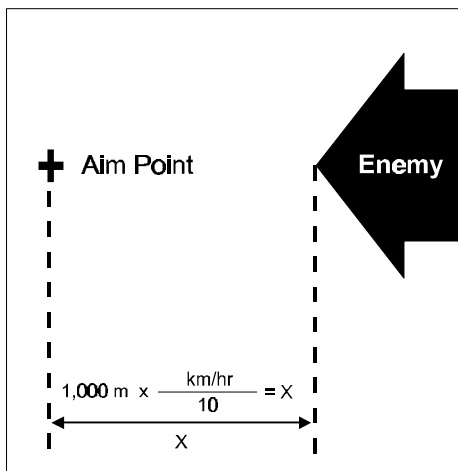

Figure 5-15. Aim Point Location for a Moving Target.

b. Stationary Targets. The aim point for a stationary target is placed directly over the target center. Aim points are located to an accuracy of 100 meters for adjust fire and 10 meters for fire for effect. If adjustment is necessary, it will be conducted with shell M483A1 in the self-registering mode.

5505. Family of Scatterable Mines Call for Fire and Adjustment. The FASCAM call for fire is usually transmitted and processed in the same manner as other requests for target-of-opportunity fire missions. The adjusting shell is DPICM in self-registration mode and shell ADAM, which is always fired last. Targets of opportunity are either fire-for-effect or adjust-fire missions. Missions within 1,000 meters of friendly forces should be

referred to the firing-unit FDC for computation of the buffer zone before firing. Adjustment procedures for FASCAM are identical to those described for ICM. Figure 5-16 shows two different examples of a FASCAM call for fire.

Fire-for-Effect Mission	
FO:	“Z57 this is Z42, fire for effect, over.”
FDC:	(FDC reads back.)
FO:	“Grid 1804 5132, over.”
FDC:	(FDC reads back.)
FO:	“Platoon in the open, ADAM, over.”
FDC:	(FDC reads back.)
Adjust-Fire Mission	
FO:	“Z57 this is Z42, adjust fire, over.”
FDC:	(FDC reads back.)
FO:	“Grid 180 513, over.”
FDC:	(FDC reads back.)
FO:	“Five T-72 tanks attacking, RAAMS in effect, over.”
FDC:	(FDC reads back.)

Figure 5-16. Example of Family of Scatterable Mines Call for Fire.

5506. Employment Considerations. Authorization for FASCAM employment is established in the OPORD and is usually held at the regimental level. Caution should be exercised when employing these mines in areas where friendly troops are likely to move. Although the mines have a self-destruct mechanism, the dud rate is comparable to that of DPICM.

Section VI. Artillery and Mortar Illumination

Battlespace illumination gives friendly forces enough light to aid them in ground operations at night. Illumination also facilitates operations for both the FO and the maneuver unit. Characteristics of artillery illumination are contained in appendix A. See chapter 6 for NGF adjustment procedures for illumination.

5601. Employment of Illumination. Illumination should be used with *caution* to avoid the accidental compromise of or interference with a friendly unit by premature or inappropriate fires. These fires must be coordinated before delivery if it is suspected that the effects of these fires will cross the boundary of an adjacent unit.

a. Volume. The amount of illumination that is required for a particular mission depends on the OT distance; the conditions of visibility; and the size, width, and depth of the area to be illuminated. By selecting the proper illuminating pattern and controlling the rate of fire, the FO can illuminate an area effectively with a minimal expenditure of ammunition. See table 5-2 on page 5-39 for the rates of fire for continuous illumination and other information on the employment of illuminating shells.

b. Uses. Illumination shells are used for the following:

- Illuminating areas of suspected enemy activity
- Providing illumination for night fires

Table 5-2. Employment Factors for Illuminating Shells.

Howitzer/ Mortar	Projectile	Initial HOB (m)	Distance Between Bursts (Spread) (m)	Burning Time (sec)	Rate of Continuous Illumination (rounds/min)	Rate of Descent (m/sec)
155 mm	M-485A2	600	1,000	120	1/2	5
81 mm	M-301A1	400	500	60	1	6
81 mm	M-301A2	400	500	60	1	6
81 mm	M-301A3	600	500	60	1	6

- Harassing enemy positions
- Furnishing directions to friendly troops for attacks or patrol activities
- Marking targets for attack by CAS
- “Washing out” enemy passive night-sight systems.

5602. Illumination Patterns

a. One-Gun Illumination Pattern. The one-gun illumination pattern is used when effective illumination can be obtained by firing one round at a time. To get this pattern, the FO calls for illumination as the type of adjustment and type of projectile.

b. Two-Gun Illumination Pattern. The two-gun illumination pattern is used when an area requires more illumination than can be

furnished by one-gun illumination. In two-gun illumination, two rounds are caused to burst simultaneously in the same place. To get this pattern, the FO requests “illumination two guns.” This pattern is not necessary with the M485A2 155-mm projectile.

c. Two-Gun Illumination Range Spread Pattern. The two-gun illumination range spread pattern is used when the area to be illuminated has greater depth than width as seen along the OTL (GTL for mortars). (See figure 5-17.) Spread illumination causes less shadow than illumination that is concentrated in one place. To get this pattern, the FO calls for “illumination range spread.” The FDC centers the spread over the point indicated by the FO and orients the spread along the OTL for artillery (unless GTL is requested) and along the GTL for mortars. (See table 5-2 on page 5-39 for distance between bursts.)

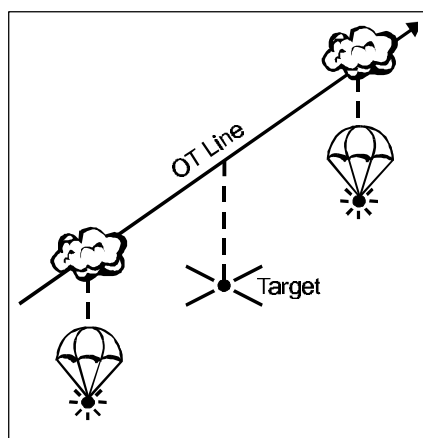

Figure 5-17. Illumination Range Spread.

d. Two-Gun Illumination Lateral Spread. The two-gun illumination lateral spread pattern is used when the area to be illuminated has greater width than depth. (See figure 5-18.) To get this pattern, the FO calls for “illumination lateral spread.” The FDC centers the spread over the point indicated by the FO and orients the spread perpendicular to the OTL for artillery and to the GTL for mortars. Distances between bursts are the same as those for a range spread.

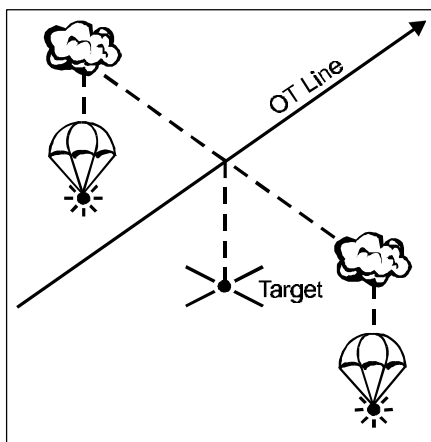

Figure 5-18. Illumination Lateral Spread.

e. Four-Gun Illumination Range and Lateral Spread. The four-gun illumination pattern is used to illuminate a large area. (See figure 5-19 on page 5-42.) Four rounds are caused to burst simultaneously parallel and perpendicular to the OTL for artillery (GTL for mortars). This pattern illuminates an area with practically

no shadows or dark spots. To get this pattern, the FO calls for “illumination range and lateral spread.” The pattern of bursts is the combination of range and lateral spreads.

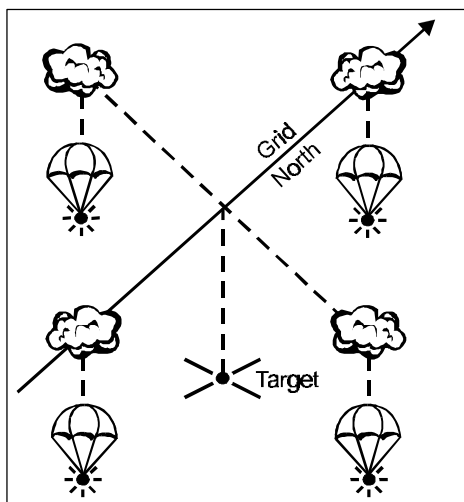

Figure 5-19. Illumination Range and Lateral Spread.

5603. Illumination Call for Fire and Adjustment

a. Call for Fire. In the illumination call for fire, “illumination” is given as the type of projectile, and, if desired, the appropriate range or lateral spread is given as the distribution. (See figure 5-20 on page 5-43 for an example of an illumination mission.)

"P53 this is P67, adjust fire, over." "Grid 616 376, over." "Vehicle noises, suspected tanks, illumination, over."

This fires illuminating round bursts about 100 mils left of the suspected area and burns out 40 mils too high (measured with binoculars). Using an OT factor of 2, the observer transmits:

"Direction 5800, right 200, down 100, over."

Deviation (100 mils x 2 = 200 meters).

HOB (40 mils x 2 = 80 meters » 100 meters).

The second round bursts short near the OTL but is too low. The round burns for six seconds on the ground. The observer requests:

"Add 400, up 50, over."

(6 x 5 = 30 meters » 50 meters).

The third round bursts at the appropriate height over the suspected area, but haze and the distance between the suspected area and the observer cause poor visibility when only one illuminating round is used. The observer believes that two rounds will be adequate to extend the visible area and reduce shadows. He requests:

"Lateral spread, over."

Two rounds burst in a lateral spread over the suspected area. The observer notices two tanks and a number of infantrymen moving to the right of the extreme edge of the illuminated area. He then prepares and transmits a second call for fire, moves his illumination over to the adjusting point, and transmits "illumination mark" when maximum illumination of the target has been obtained:

"Right 400, coordinated illumination, over." "Adjust fire, over." "Grid 611 382, over." "Two tanks and platoon of infantry, ICM in effect, over."

The observer may also have sent his target location by polar plot ("Adjust fire, polar, over.") or by shifting from the center of the illumination ("Adjust fire, shift, illumination, over.").

The observer transmits "illumination mark" when maximum illumination of the target has been obtained. He then adjusts the HE and fires for effect.

Figure 5-20. Example of Illumination Mission.

b. Adjustment. Procedures for adjusting illumination are discussed below.

(1) Range and deviation corrections are made in 100-meter increments. The adjustment of illumination to within 200 meters of the adjusting point is considered to be adequate because of the size of the area illuminated by the flare. Range and deviation corrections of less than 200 meters should not be made.

(2) The correct position of the flare in relation to the area to be illuminated depends on the terrain and wind. Generally, the flare should be to one flank of the area and at about the same range. In a strong wind, the point of burst must be upwind from the area to be illuminated because the flare will drift. If the area is on a forward slope, the flare should be on the flank and at a slightly shorter range. For illuminating a very prominent object, visibility is better if the flare is placed beyond the object so that the object is silhouetted.

(3) The proper HOB is obtained when the flare burns out just as it strikes the ground. HOB corrections are made in multiples of 50 meters. Variations in time of burning between individual flares make any finer adjustment of the HOB impractical. When burnout occurs during descent, the HOB correction is made by estimating the height of the flare when it burned out. When visibility permits, the spotting (height of the burnout above the ground) may be measured with binoculars. The HOB spotting (in mils) is multiplied by the OT factor to determine the height of burnout (in meters). The height is expressed to the nearest 50 meters and is sent as a down correction.

Example

The flare burns out 20 mils above the ground. The OT factor is 3. The correction is “down 50” (20 mils x 3 = 60 (50 meters)).

When the flare continues to burn after it strikes the ground, a correction is required to raise the HOB. The length of time in seconds that the flare burns on the ground is counted and multiplied by the rate of descent. (See table 5-2 on page 5-39.) The product is expressed to the nearest 50 meters and sent as an up correction.

Note

When using a night observation device, the FO should ensure that the flare burns out appreciably (100 - 200 meters) above the adjusting point to keep the device from washing out.

5604. Coordinated Illumination. When the FO has located a target suitable for HE or other fire, he initiates a call for fire by announcing “coordinated illumination” and then the mission data. (See figure 5-20 on page 5-43.) If no better means of designating the location of the target is possible, the burst center of the illumination can be used as a reference point.

Example

“Illumination right 200, HE add 100.”

Once the FO has adjusted the illuminating shell to the desired location, he should control the rate of fire and the number of pieces

firing. He should reduce the ammunition expended to the minimum required for observation.

a. Fire Direction Center Control. The FO allows the FDC to control firing of both illumination and HE by announcing “coordinated illumination” in his call for fire. While adjusting the illumination to yield the best light on the target, the FO should announce “illumination mark” to the FDC to notify it of the exact time when the target is best illuminated. Several marks may have to be established because a new mark must be established each time the illumination is corrected. By marking the adjusting rounds, the FO avoids the need for a separate illumination round to mark. The FDC times the interval between the actual firing of the illuminating round and the receipt of the FO’s “illumination mark.” By comparing this time interval with the TOF of the HE, the FDC can control the firing of the HE rounds so that they arrive at the target during the period of maximum illumination. If the FO adjusts the illuminating fire and the HE fire concurrently, he begins corrections pertaining to illumination with the word “illumination” and those pertaining to HE with “HE.”

b. Observer Control. As an alternate method, the FO may request “coordinated illumination” and announce the method of control as “by round at my command” for both missions. This indicates that both HE and illumination will be fired only at the FO’s command. In this method, the observer is responsible for timing his own mark and incorporating the HE TOF into the delivery of fires. As soon as the FDC reports that the illumination and HE fires are ready, the FO commands the firing of illumination. Then the FO commands

the firing of the HE so that it will impact during maximum illumination of the target. The FO must request the HE TOF to better coordinate the firing of each round. An experienced FO and battery may be able to adjust more than one HE round under each round of illumination.

5605. Continuous Illumination. Because of the amount of ammunition expended, the least desirable method of coordinated illumination is for the FO to request “continuous illumination.” In this technique, the FDC fires illumination continually (intervals between firing depend on the type of projectile) while the FO adjusts the HE. This is acceptable when illumination is enhancing the performance of optics in acquiring direct-fire targets.

Section VII. Smoke

The main objective of employing smoke is to create a *one-way mirror* so that forces may attack but not be seen by the enemy. Smoke is a combat multiplier that can be used in many ways to help accomplish the mission. Smoke can conceal both friendly and enemy troop movements, slow attacking forces, disrupt command and control, and reduce exposure of critical friendly and enemy assets. Observers must synchronize, integrate, and sustain smoke to defeat enemy electro-optical systems. Smoke at the critical time and place helps the combined-arms team to accomplish its mission. The force that most effectively employs smoke and functions better in limited visibility has the advantage in battle.

5701. Categories of Smoke. Smoke is categorized as deliberate or hasty.

a. Deliberate. Deliberate smoke is normally employed at the regimental level or higher. Any smoke source can provide deliberate smoke. Deliberate smoke can conceal forces or protect large areas (several square kilometers) behind the forward line of troops with smoke generators supplemented by smoke pots. This requires large amounts of fuel, fog oil, and munitions as well as extensive use of artillery assets and scarce smoke generators. Point or small-area targets can be obscured by other smoke assets (artillery, mortars, NGF, and air-to-ground rockets).

b. Hasty. Smoke in hasty operations is often used by battalions and smaller units against immediate tactical threats. Hasty smoke employs the unit's basic load of smoke-producing sources in addition to rapid-response assets like mortars and artillery. These operations typically require short planning and execution times, minimal coordination, relatively short duration of effects, and the use of organic assets. Hasty smoke obscurants are created to support small-unit maneuver or disengagement. Units must carefully plan the operational and logistical support for using hasty smoke.

5702. Battlespace Applications. The battlespace applications for using smoke in deliberate and hasty operations are obscuring, screening, marking, and/or deceiving.

a. Obscuring. Obscuring smoke is used to degrade the enemy's combat effectiveness. Obscuring smoke is placed on or near the enemy to suppress enemy observers and to minimize their vision and/or their ability to command and control their forces.

b. Screening. Screening smoke is used to conceal friendly forces, positions, and activities from enemy ground or air observation. Screening smoke is normally placed between friendly and enemy forces.

c. Marking. Marking smoke is used to identify targets for aircraft, to identify friendly locations, or as a navigational aid. It can also be used to signal prearranged battlespace cues.

d. Deceiving. Deceiving smoke is used to mislead the enemy about friendly force intentions. Deceiving smoke can support the deception plan by drawing attention away from the main effort.

5703. Delivery Systems

a. Mortars. Mortar units can deliver a high volume of smoke at short to medium ranges. Mortars generally provide the most rapid and responsive fires for the commander. The various types of mortar smoke include WP and red phosphorus (RP). (See table 5-3 on page 5-50.)

Table 5-3. Smoke Munitions Data.

Delivery System	Type of Round	Time To Build Effective Smoke	Average Burning Time	Average Obscuration Length (m/Round)	
				Crosswind	Headwind/Tailwind
155 mm	HC	1 - 1½ min	4 min	350	75
	WP	½ min	1 - 1½ min	150	50
	M825	½ min	5 - 8 min	350	100 - 200
81 mm	WP	½ min	1 min	100	40
	RP	½ min	1½ - 2 min	90 - 150	40 - 50
60 mm	WP	½ min	1 min	75	40
5-inch/54	WP	½ min	1 min	150	40
Note: Planning factors are meteorologically dependent. Data is based on favorable conditions.					

(1) White Phosphorus Smoke. WP is available from company mortars (M224 60 mm) and battalion mortars (M252 81 mm). Mortar WP produces rapid smoke buildup, but its effects are of limited duration. It can be used for marking targets.

(2) Red Phosphorus Smoke (M819). RP is a time-fuzed round that contains RP smoke pellets. At a preset time along the round's trajectory, the fuze functions to expel and ignite the RP pellets at an approximate HOB of 175 meters. The burning pellets produce a cloud of dense smoke after hitting the ground. A three-round volley is required to develop the basic smoke screen. RP smoke is available from 81-mm mortars only.

b. Artillery. Various smoke munitions can be fired by cannon artillery. The artillery provides smoke at short, medium, and long ranges. Artillery units can provide longer, more effective smoke effects than the mortar platoons. However, excessive use of smoke should be planned and coordinated so that artillery units can meet the commander's needs. The types of artillery smoke are hexachloroethane (HC), WP, and M825 improved smoke (felt-wedge WP). (See table 5-3.)

(1) White Phosphorus Smoke. This type of artillery smoke involves a canister filled with WP. It is either PD or time fuzed. It is the primary marking round and builds quickly but has little sustainment. With a time fuze, it disperses more for obscuring. It is not fired with fuze VT.

(2) Hexachloroethane Smoke. HC is time fuzed and functions at a HOB of approximately 50 meters. The HC smoke canisters are expelled from the projectile and disperse in the target area. It is slow building but is effective for screening.

(3) M825 Improved Smoke. M825 has replaced HC smoke rounds. It is a canister filled with WP-impregnated felt wedges that are expelled from the base. It is time fuzed and functions at a predetermined HOB that varies with the propellant and charge fired. The wedges build rapidly into an effective screen with lasting duration.

Note

Soft sand or mud can prevent wedges from completely burning; this poses a nonlethal hazard to maneuvering forces when wedges are reexposed to

5704. Smoke Planning Considerations. The factors to consider when planning smoke are weather, terrain, means available, ammunition, the enemy, and command and control. On the basis of these factors, the FO can advise the company commander on the feasibility or likely performance of smoke.

a. Weather. Weather aspects are interrelated. The wind, temperature gradient, humidity, precipitation, and cloud cover will indicate the effectiveness of smoke and the volume required. Wind speed and direction are the primary factors in smoke performance.

(1) Wind Speed. Wind speed indicates whether smoke will be effective. High winds push smoke down, and effective smoke will not thicken until it has blown farther downwind. Low winds allow smoke to billow high and thicken closer to its source. Figure 5-21 on page 5-53 shows the optimal wind speeds for smoke. The equivalent wind-speed scale, the grass drop/flag method, and the onboard computer of the M1A1 are valid methods to determine wind speed.

(a) Equivalent Wind Scale. The observer can use table 5-4 on page 5-53 to determine wind speed. It is the least accurate and most subjective of all of the methods.

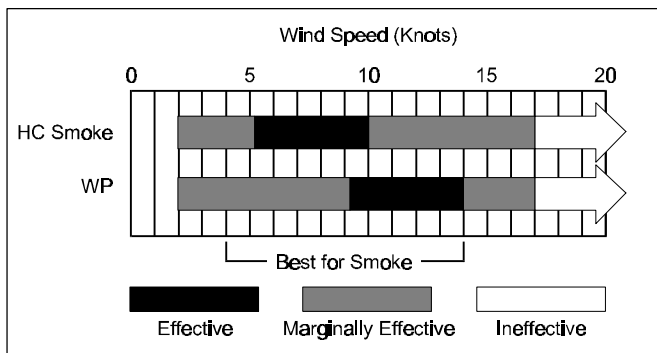

Figure 5-21. Optimal Wind Speeds.

Table 5-4. Equivalent Wind-Speed Scale.

Knots	Observation
1	Smoke, vapor from breath, and dust raised by vehicles or personnel rise vertically. No leaf movement.
1 - 3	Direction of wind slightly shown by smoke, vapor from breath, or dust raised by vehicles or personnel. Slight intermittent movement of leaves.
4 - 6	Wind slightly felt on face. Leaves rustle.
7 - 10	Leaves and small twigs in constant motion.
11 - 16	Wind raises dust from ground. Loose paper and small branches move.
17 - 21	Small trees with leaves sway. Coastal wavelets form on inland waters.
22 - 27	Large branches on trees in motion. Whistle heard in telephone or fence wires.
28 - 33	Whole trees in motion. Inconvenience felt walking against wind.

(b) The Grass Drop Method or Flag Method. The grass drop and flag methods are better ways to determine wind speed. Extend



the arm downwind and parallel to the ground. Drop some grass from the hand and point to the grass on the ground. Estimate the angle formed by the arm and torso, in degrees, and divide by four to determine wind speed in knots. The flag method is similar. Use a flag or lightweight strip of cloth attached to a vertical object. Estimate the angle of the flag/cloth and the vertical object, in degrees, and divide by four to determine wind speed in knots.

(c) Onboard Computer of the M1A1 Tank. The observer uses the onboard computer to determine the wind speed at the tank location. This is the most accurate method of wind measurement.

(2) Wind Direction. Computations are used to determine the local-area wind direction. Local-area wind direction indicates where the smoke will travel. Wind direction is measured as a horizontal clockwise angle, in mils, from grid north. It extends from the direction from which the wind is blowing to the direction to which the wind is blowing. A field-expedient method of determining wind direction is to face away from the wind and measure the actual wind direction with a compass.

(3) Temperature Gradient. Temperature alone has no direct impact on the effectiveness of smoke. Temperature gradients do, however, directly affect smoke performance. Temperature gradients are determined by comparing air temperatures at 0.5 meters and four meters. Unstable, neutral, and stable are the three general temperature gradients used. Table 5-5 on page 5-55 is used for predicting these conditions and how the smoke will perform under these conditions.

Table 5-5. Temperature Gradients.

Smoke Condition (Temperature Gradient)	Time of Day Weather Conditions	Expected Smoke Behavior as The Smoke Drifts Downwind (Wind Direction →)
FAVORABLE (Inversion)	1. Night - Until 1 hour after sunrise. 2. Wind speed less than 5 kts. 3. Sky cover less than 30 percent. ALL THREE CONDITIONS MUST BE MET.	 <p>Stable condition - Favorable for smoke employment.</p>
MODERATELY FAVORABLE (Neutral)	This condition occurs most often 1-2 hours before and after sunrise and when the wind speed is 5 kts or more and/or the sky cover is 30 percent or more.	 <p>Neutral condition - Moderately favorable for smoke employment.</p>
MARGINAL (Lapse)	1. Day - beginning 2 hours after sunrise. 2. Wind speed less than 5 kts. 3. Sky cover less than 30 percent. ALL THREE CONDITIONS MUST BE MET.	 <p>Unstable condition - marginal for smoke employment.</p>

(a) *Unstable conditions* exist when the air temperature decreases with an increase in altitude. An unstable condition is characterized by vertical air currents and turbulence. Smoke tends to break up and become diffused under these conditions. Unstable conditions should be considered by planners as marginal for smoke employment.

(b) *Neutral conditions* exist when an increase in altitude is accompanied by little or no change in air temperature. Limited

vertical air currents also cause neutral conditions when the wind speed is greater than five knots. Planners should consider neutral conditions as moderately favorable for smoke employment.

(c) *Stable (inversion) conditions* exist when the air temperature increases with an increase in altitude. This condition greatly limits vertical air currents. Smoke produced during inversion conditions lies low to the ground and may reduce visibility at ground level. Stable (inversion) conditions should be considered favorable by planners for smoke employment if there is enough wind to carry the smoke over the target area.

(4) Humidity. WP, RP, and HC smoke are hygroscopic and produce smoke particles that absorb moisture from the air. Moisture increases particle size and density and makes the smoke more effective. Smoke munitions generally produce denser, thicker smoke in high humidity than in low humidity. High humidity is generally favorable for smoke employment.

(5) Precipitation. Precipitation is a natural obscurant. Using smoke in mist or fog produces thicker smoke that is more effective against electro-optical systems. Light rain produces moderately favorable conditions for using smoke because the smoke might not rise high enough to produce effects. Heavy rain and snow are effective natural obscurants themselves and will degrade electro-optical systems effectively. As a general rule, precipitation pushes smoke down to the ground and spreads it over larger areas.

(6) Cloud Cover. Clouds will give an indication of how smoke will perform in the battlespace. As a general rule, the atmosphere is stable (favorable) when the sky is covered with clouds. Scattered clouds indicate moderately favorable conditions. No cloud cover indicates marginal conditions.

b. Terrain. Winds follow the contours of the Earth. The type of terrain over which smoke travels has a tremendous effect on how the smoke will cover a specific area. Flat, unbroken terrain creates effective smoke farther downwind. Trees and small buildings tend to break up smoke, which may then reform to cover a larger area and create effective smoke near the source. Steep hills or mountains create volatile winds, usually resulting in gaps and uneven smoke. Slopes and valleys create thermal slope winds at different times. Heating effects during the day cause up-slope winds. Cooling effects at night cause down-slope winds. Table 5-6 on page 5-58 summarizes atmospheric and terrain effects on smoke operations.

c. Means Available. Observers recommend to maneuver commanders the best means of providing smoke. Higher level FSCCs must review and then approve, modify, or deny this request on the basis of the effects of the smoke on all maneuvers.

d. Ammunition. Smoke ammunition is a limited asset. Because ammunition requirements vary with each mission, observers should know the amount and types of smoke ammunition available and how many minutes of coverage it can provide. Extensive, planned smoke employment should be coordinated early with firing units to allow for redistribution or requisition of ammunition.

Table 5-6. Terrain and Atmospherics.

Factor	Unfavorable	Moderately Favorable	Favorable
Wind	More than 10 knots	Less than five knots	5 to 10 knots
Atmospheric stability category	Unstable (lapse) (favorable for smoke curtain)	Neutral	Stable (inversion) (unfavorable for smoke curtain)
Humidity	Low	Moderate	High
Precipitation	None	Light rain	Mist/fog
Cloud cover	None	Scattered	Overcast, low ceiling
Terrain	Even	Gently rolling	Complex topography
Vegetation	Sparse or none (desert)	Medium to dense	Heavily wooded or jungle
Time of day	Late morning through late afternoon	Mid-morning	1 hour before EENT to 4 hours after BMNT
Legend: BMNT = beginning of morning nautical twilight EENT = end of evening nautical twilight			

e. The Enemy. When considering smoke employment, the enemy's electro-optical capability should be known and likely positions for his weapons systems and observers that may threaten friendly forces should be anticipated. On the basis of the commander's plan, observers should determine when smoke employment will enhance friendly operations and hinder enemy operations.

f. Desired Effects. Clearly stated guidelines, restrictions, desired effects against enemy electro-optical systems, and other smoke employment instructions should be part of the commander's guidance and unit SOPs. Desired effects are specified as visible or infrared. All types of smoke are capable of producing visible and infrared effects. Table 5-7 on page 5-60 shows the effectiveness of the types of smoke against enemy and friendly electro-optical systems. Figure 5-22 on page 5-61 shows the effectiveness of all types of obscurants against enemy and friendly electro-optical systems.

(1) Visible. The visible wavelength is relatively easy to defeat with smoke. Obscurants hinder enemy viewers such as binoculars, weapons sights, night observation sights, and laser rangefinders.

Smoke can also degrade friendly visibility. Smoke that is sufficient to degrade less sophisticated electro-optical systems may be relatively ineffective against more sophisticated electro-optical systems. Infrared device-equipped observers have an inherent tactical advantage over observers who rely solely on the visible wavelength. With infrared devices, observers can more easily acquire targets through smoke, although positive target identification is more difficult.

Table 5-7. Smoke Effects on Electro-optical Systems.

5-60

Spectral Region	Electro-optical System	Type of Smoke
Visible 0.40 - 0.75 μ m	Viewers: <ul style="list-style-type: none"> • Daylight sights • Naked eye • Camera lens • Binoculars/standard optics • Battlespace television • Manual command to line of sight (MCLOS) missiles (AT-3) • Night sights 	All
Near infrared 0.75 - 4 μ m	Viewers: <ul style="list-style-type: none"> • Semiautomatic command to line of sight (SACLOS) missiles (AT-4 and AT-5) • Night sights 	All
	Sensors: <ul style="list-style-type: none"> • Laser designators • Laser rangefinders 	All
Mid infrared 4 - 14 μ m	Viewers: <ul style="list-style-type: none"> • Passive thermal sights 	WP, RP, type III infrared obscurant, dust
Far infrared 14 - 100 μ m	Sensors: <ul style="list-style-type: none"> • Thermal imagers • Terminal homing missiles (AT-6) 	WP, RP, type III infrared obscurant, dust
Millimeter wave and lower frequency 1.00 mm	Radar Radio Microwaves	WP, developmental obscurants
X-ray and higher frequency	Directed electromagnetic pulse Nuclear weapons	Oil smoke (attenuation only), developmental obscurants

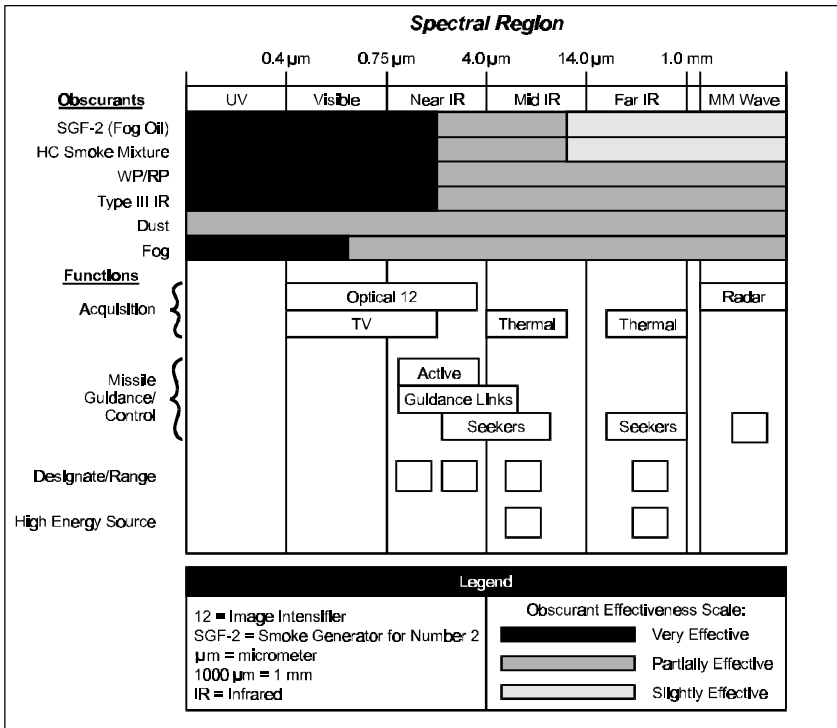

Figure 5-22. Obscurant Effects on Electro-optical Systems.

(2) **Infrared.** Visual obscurants may degrade the visibility of observers using infrared devices. Bispectral obscurants, however, can defeat sophisticated battlespace viewers and weapon guidance systems such as command line-of-sight or terminal homing systems on antitank missiles. Bispectral obscurants defeat or degrade both the visual and infrared portions of the electromagnetic spectrum simultaneously. Firing units employing bispectral fires deliver

sufficient amounts of smoke to degrade less sophisticated as well as advanced electro-optical systems as necessary. Like visual obscurants, bispectral obscurants can degrade both enemy and friendly systems. Bispectral obscurants are required to defeat an enemy that is equipped with more sophisticated electro-optical technology.

5705. Types of Smoke Missions. Immediate smoke and quick smoke are the two types of smoke missions that are fired by the artillery and mortars.

a. Immediate Smoke. Immediate smoke provides obscuring, protecting, or marking smoke over small areas. It is more responsive than quick smoke, but the duration and area of effects are limited. Immediate smoke is effective against point targets for short periods. Unit SOPs should state the amount and type of ammunition to be fired and the number of guns to be used.

(1) Adjusting Point. The adjusting point for immediate smoke is normally the target itself. However, the observer may determine that offsetting his adjusting point into the wind may produce better obscuration. When offsetting the adjusting point, use the criteria listed in figure 5-23 on page 5-63.

(2) Requesting Immediate Smoke. The call for fire for immediate smoke consists of four elements sent in one transmission. The four elements are observer identification, warning order, target location, and transmission authentication.

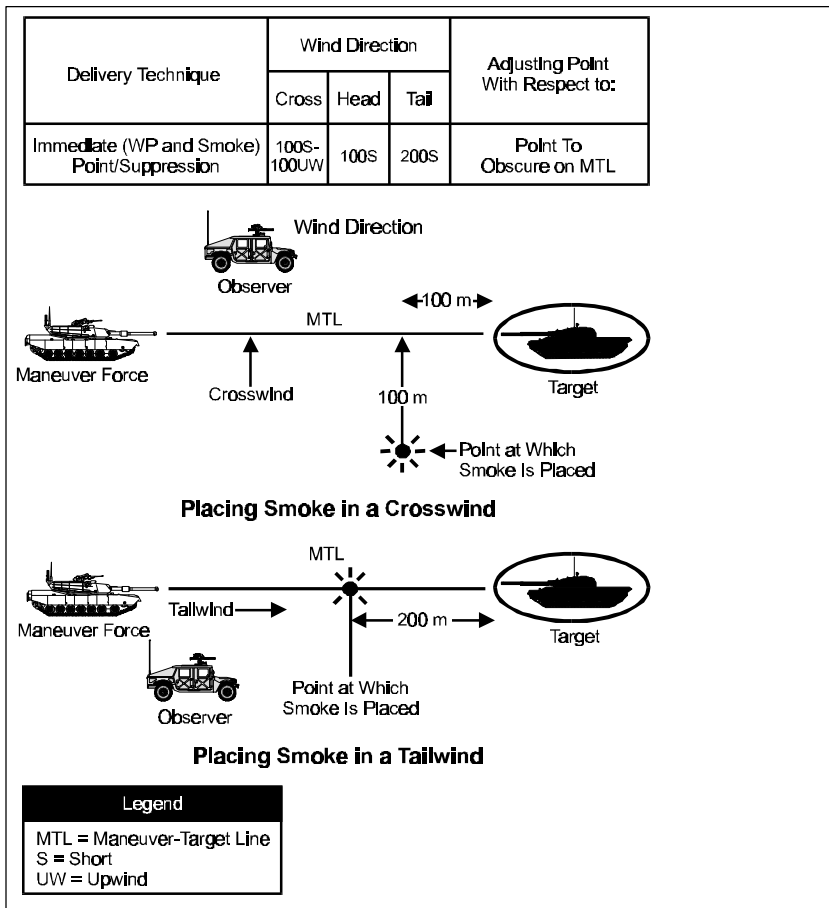

Figure 5-23. Optional Adjusting Points for Immediate Smoke.

(a) Observer Identification. The observer's call sign identifies him to the FDC.

(b) Warning Order. The observer announces “immediate smoke.”

(c) Target Location. Any method of target location may be used.

(d) Transmission Authentication. Proper transmission authentication at the end of the call for fire is required.

Example (Grid)

FO: “W52 this is H24, immediate smoke, grid 628 545, I authenticate ROMEO DELTA, over.”

FDC: (Reads back.)

Example (Shift From Known Point)

FO: “W52 this is H24, immediate smoke, shift target number AB3058, direction 4360, left 130, add 300, I authenticate MIKE LIMA, over.”

FDC: (Reads back.)

Example (Polar)

FO: “W52 this is H24, immediate smoke, polar, direction 4360, distance 2700, up 30, I authenticate PAPA KILO, over.”

FDC: (Reads back.)

Example (Laser Polar)

FO: “W52 this is H24, immediate smoke, laser polar, direction 4362, distance 2730, vertical angle plus 11, I authenticate CHARLIE ALFA, over.”

FDC: (Reads back.)

b. Quick Smoke. Quick smoke provides obscuring, screening, or deceiving smoke over larger areas. More planning and coordination are required for quick smoke than for immediate smoke. Smoke rounds for quick smoke missions are fired in a linear sheaf and cover larger areas than are covered by immediate smoke missions.

(1) Planning Quick Smoke Missions. Quick smoke is effective against enemy positions and formations. A standard call for fire includes target location, target description, length of the sheaf, direction of the maneuver-target line (MTL), direction of the wind in relation to the MTL, desired time, and duration and effects of the smoke. Fire for effect should be requested for planned targets or refined target locations. Adjust fire can be conducted when the method of target location is less accurate. When adjusting fire, provide OT direction for grid missions.

(a) Target Location. Any method of target location may be used. The target location is the center of the area where the screen needs to be most effective. Note that adjusting rounds are delivered to where the screen is planned. However, during the fire for effect, smoke rounds will be offset by the FDC for the effects of wind.

(b) Target Description. Announce “screen” followed by an accurate target description. “Screen” alerts the FDC that smoke mission data will follow. Target descriptions such as open area, tree line, or hilltop are inappropriate. If the enemy situation is vague or unknown, transmit a description of the suspected target for screening.

(c) Length of the Smoke Sheaf. In coordination with the commander, determine the area to obscure, screen, protect, or deceive. The actual length of the smoke sheaf in meters is then determined. A recommendation should then be made to the commander regarding the length of the sheaf and the weapons system that should be used.

(d) Determining the Maneuver-Target Line. The MTL is a horizontal clockwise angle measured from grid north. Depending on the situation, the MTL can extend from the observer's location to and through the target, or it can extend from the most vulnerable point along the route of march to and through the target. The MTL is determined to an accuracy of 10 mils.

(e) Determining the Wind Direction in Relation to the Maneuver-Target Line. Determine whether the wind is a right crosswind, left crosswind, headwind, or tailwind in relation to the MTL. A left crosswind blows from left to right across the MTL from the observer's perspective. A right crosswind blows from right to left across the MTL from the observer's perspective. A headwind blows along the MTL toward the observer. A tailwind blows along the MTL away from the observer. Figure 5-24 shows how to convert the wind direction in relation to the MTL to a right crosswind, left crosswind, headwind, or tailwind. To compute the difference between the actual wind direction and the direction of the MTL, see figure 5-24 on page 5-67.

(f) Desired Time and Duration of Smoke Effects. Consult with the commander to determine how long the smoke effects are required. In the offense, the duration of required smoke effects is based on the friendly unit's average rate of speed and the distance of the friendly movement. In the defense, it is based on the enemy's closure rate and the distance that he needs to cover before he can be effectively engaged.

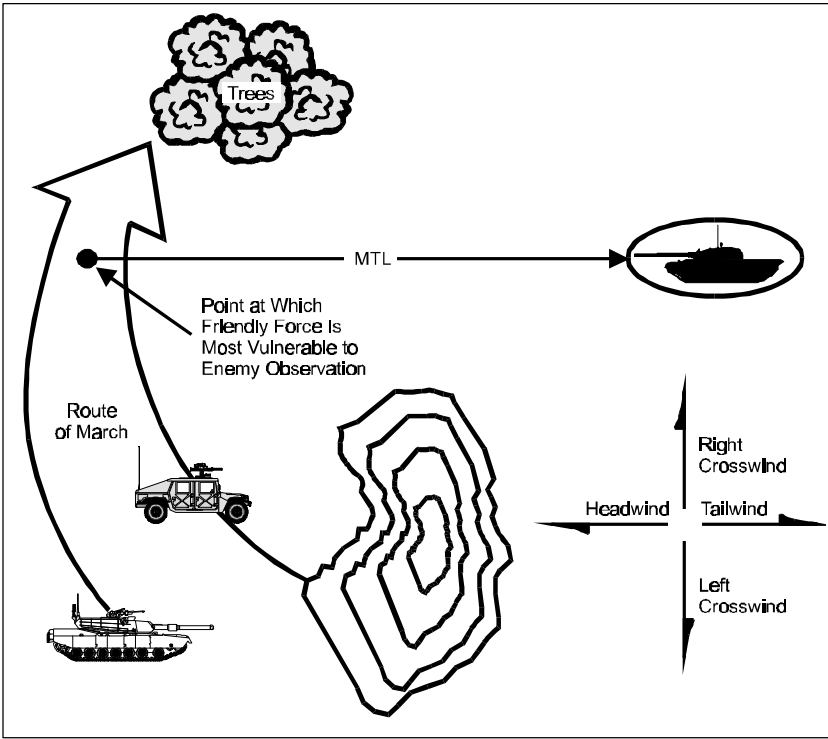

Figure 5-24. Determining Wind Direction in Relation to the Maneuver-Target Line.

(g) Desired Smoke Effects. Announce “smoke” or “infrared smoke” to describe the desired effects of the smoke mission. “Smoke” is a request for visible effects. “Infrared smoke” is a request for infrared effects.

(h) Feasibility. During planning, the observer can provide mission information to the FDC and allow it to compute the number of rounds required for support. This allows feasibility assessment, as well as ammunition preparation. The FDO will select the appropriate smoke munition that will produce the requested effects.

(2) Requesting Quick Smoke. Quick smoke is requested by using the six elements of the standard call for fire. These elements are sent in three transmissions.

(a) Observer Identification. This identifies the observer to the FDC.

(b) Warning Order. Announce “fire for effect” or “adjust fire.”

(c) Target Location. Use any of the four methods of target location.

(d) Target Description. Announce “screen” followed by the actual or suspected target description.

(e) Method of Engagement. Announce the length of the smoke sheaf, MTL, direction of the wind in relation to the MTL, and desired time and duration of smoke effects. Use the memory aid “L-M-Dir-T,” which stands for the following:

- L—length of the linear smoke sheaf
- M—MTL direction

- Dir—direction of the wind in relation to the MTL
- T—desired time and duration of smoke effects in minutes.
(Following this, announce either “smoke” or “infrared smoke.”)

(f) Method of Fire and Control. Method of fire is not normally requested. However, any method of control can be specified based on the tactical situation.

Example (Grid Method)

FO: “W52 this is H24, adjust fire, over.”

FDC: (Reads back.)

FO: “Grid 617 538, over.”

FDC: (Reads back.)

FO: “Screen T-55 company dug in, length 600, MTL 1850, right crosswind, five minutes, smoke in effect, over.”

FDC: (Reads back and challenges.)

FO: (Replies.)

FDC: (Announces MTO.)

FO: (Reads back MTO.)

5-70

Example (Shift Method)

FO: "R5M this is M24, fire for effect, shift target number AB3062, over."

FDC: (Reads back.)

FO: "Direction 4570, right 280, add 400, down 35, over."

FDC: (Reads back.)

FO: "Screen suspected combat OP, length 200, MTL 0120, left crosswind, five minutes, infrared smoke, over."

FDC: (Reads back and challenges.)

FO: (Replies.)

FDC: (Announces MTO.)

FO: (Reads back MTO.)

Example (Polar Method)

FO: "W5H this is H24, fire for effect, polar, over."

FDC: (Reads back.)

FO: "Direction 4420, distance 2700, up 45, over."

FDC: (Reads back.)

FO: "Screen BRDM-2 with AT-5, length 200, MTL 5240, tailwind, 10 minutes, infrared smoke, time on target 0615, over."

FDC: (Reads back and challenges.)

FO: (Replies.)

FDC: (Announces MTO.)

FO: (Reads back MTO.)

Example (Laser Polar Method)

FO: "W5H this is H24, fire for effect, laser polar, over."

FDC: (Reads back.)

FO: "Direction 4514, distance 4170, vertical angle plus six, over."

FDC: (Reads back.)

FO: "Screen BMP-2 platoon with AT-5s, length 400, MTL 4510, headwind, 10 minutes, infrared smoke, at my command, over."

FDC: (Reads back and challenges.)

FO: (Replies.)

FDC: (Announces MTO.)

FO: (Reads back MTO.)

(3) Adjustment Procedures for Quick Smoke. Shell HE is used in adjustment for quick smoke missions. HC smoke adjusts the HOB before firing for effect, but M825 does not. When firing HC smoke, request “smoke” when splitting the 200-meter bracket (within 100 meters of the target). After observing the smoke round, apply a HOB correction and fire for effect. When firing M825 smoke, the same adjustment procedures as for DPICM are used. No HOB adjustment rounds are necessary; fire for effect when splitting the 200-meter bracket. Carefully analyze the behavior of the smoke to ensure effective smoke coverage. Make deviation, range, and HOB corrections from the center of the smoke sheaf as required. Because the smoke will cover a larger area, minimum corrections are as follows:

- Deviation—left/right 50 meters
- Range—add/drop 100 meters
- HOB—up/down 50 meters.

(a) Adjusting White Phosphorus Smoke. WP is adjusted for range and deviation only when it is fired with a PD fuze. When it is employed with a time fuze, it is adjusted for HOB to 20 meters.

(b) Adjusting Hexachloroethane Smoke. Range, deviation, and HOB corrections are sent when necessary. Range and deviation correction criteria are used as previously stated. The following automatic corrections are used for adjusting HC-smoke HOB:

- Ground burst—up 100

- Bouncing canisters—up 50
- Canisters too spread out—down 50.

(c) Adjusting M825 Improved Smoke. Range, deviation, and HOB corrections may be sent when necessary. Range and deviation corrections are used as previously stated. However, M825 improved smoke rarely requires HOB corrections. If the observer spots the M825 as graze, he must immediately announce “graze” to the FDC. The FDC must verify that the firing data were correct. HOB corrections for M825 smoke are announced in 50-meter increments. The following HOB corrections will be used for M825 smoke:

- Graze/firing data correct—up 100
- Thick/dense separated clouds—up 50
- Thin/uneven clouds—down 50.

(d) Adjusting Red Phosphorus Smoke. Range, deviation, and HOB corrections may be sent when necessary. Range and deviation corrections are used as previously stated. However, RP rarely requires HOB corrections. Use the M825 HOB adjustment criteria for RP smoke.

5706. Safety Considerations. HC smoke is carcinogenic. All types of phosphorous munitions produce phosphoric acid, which is poisonous. Personnel must wear respiratory protection (e.g., protective masks) when operating in HC smoke and while exposed to phosphorous smoke. M825 felt wedges and RP smoke pellets

sometimes do not burn completely. This is referred to as “crusting over.” Crusted-over felt wedges and pellets will reignite when disturbed and could cause serious burns. Personnel should be warned of their use in the area or areas that they will occupy.

Section VIII. Artillery and Mortar Final Protective Fires

FPF is “an immediately available prearranged barrier of fire designed to impede enemy movement across defensive lines or areas.” (Joint Pub 1-02) FPFs consist of final protective lines (FPLs) and principal directions of fire (PDFs) from direct-fire weapons and continuous indirect-fire barrages. In artillery, a battery is assigned one FPF. In mortars, an FPF may be assigned to a squad, a section, or the platoon. The size of the FPF depends on the type and number of weapons. (See table 5-8.) Once assigned the FPF, the firing unit remains laid on that data in between missions and prepares ammunition. A unit cannot be laid on both an FPF and a priority target.

Table 5-8. Final Protective Fires.

Weapon	Size (m)
60-mm mortar Section (3 tube)	60 x 30
81-mm mortar Platoon (8 tube) Section (4 tube) Weapon (1 tube)	280 x 35 140 x 35 35 x 35
155-mm howitzer Battery (6 gun)	300 x 50

5801. Employment of Final Protective Fires. The location of FPF normally is designated by the supported commander for whom it is being planned. It may be any distance from the friendly position that supports the current tactical situation within range of organic direct-fire weapons. This is normally within 200 to 400 meters (danger close). The importance of accurate defensive fires and the danger close situation usually requires that each weapon firing the FPF be adjusted into place, if possible.

5802. Final Protective Fire Procedures. FPF can be either adjusted or nonadjusted. Considerations include the tactical implications of adjusting the FPF (loss of surprise) versus the accuracy that is acquired for firing close to friendly troops. If adjusting, the initial target location sent is not the location of the center of the FPF but a grid that is a safe distance (400 to 600 meters) from friendly troops. Because this grid is part of a final defensive plan, it should be encrypted. The call for fire is similar to the normal call for fire with the exception of the third transmission. The attitude or direction of the long axis of the FPF is announced. In target description, "final protective fires" is announced. "Danger close" is announced in the method of engagement. "Fuze delay" should be requested whenever possible to minimize the safety hazard to friendly units while providing close-in fires.

a. Executing the Final Protective Fire. Once established, the FPF is initiated by the company commander. The observer fires the artillery FPF, using an established code or announcing "fire the FPF" with the appropriate authentication. To halt firing of the FPF,

the command “cease loading” or “check firing” is given. To terminate the FPF, “cancel FPF” is announced.

b. Adjusted Final Protective Fires

(1) Manual Fire Direction Centers. The procedures for mortar FDCs and manual artillery FDCs are the same. The entire battery or mortar platoon fires one round (a battery/platoon one volley) centered on the initial grid sent by the FO. If the rounds impact as shown in figure 5-25, the FO begins his adjustment with the flank piece impacting closest to the FPF line (in this case, number 1). Creeping fire adjustment procedures must be used in danger close situations. The following is an example of the first correction.

Example
“Number 1, right 100, drop 50, over.”

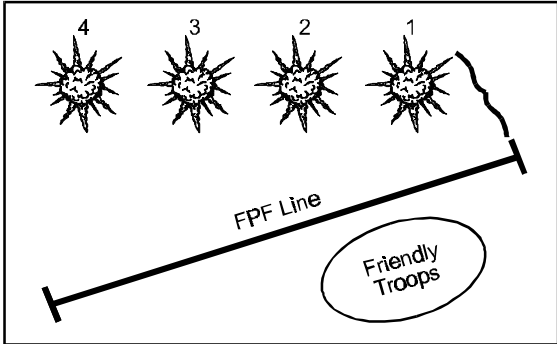

Figure 5-25. Adjustment of Final Protective Fires.

Corrections are made and fired until the FO believes that he can make a final correction to within 50 meters of the FPF line. The FO then sends a final correction, states that the weapon is adjusted, and calls for the next weapon to be adjusted. This final adjustment of 50 meters or less is computed and recorded but not fired. (See figure 5-26.)

Example

"Number 1, drop 30, number 1 is adjusted, number 2, repeat, over."

"H12 this is H18, adjust fire, over."

(FDC reads back.)

"Grid 6732 8674, altitude 710, over." (Encoded when not radio encrypted.)

(FDC reads back.)

"Final protective fire, attitude 1900, danger close, delay, over."

(FDC reads back.)

(The unit fires a battery one round with a sheaf as shown in figure 5-25. The FO observes that gun number 1 is closest to the FPF line and begins adjustment with number 1.)

"Direction 0810, number 1, right 100, drop 50, over."

(FDC reads back.)

(The unit fires the adjustment, and the FO believes that he can make a final correction to within 50 meters of the FPF line.)

"Number 1, drop 30, number 1 is adjusted, number 2 repeat, over."

(FDC reads back.)

(The FDC makes this adjustment, records the adjusted data as the priority target for gun number 1 but does not fire this adjustment, then fires gun number 2. This procedure is continued until all guns are adjusted.)

**Figure 5-26. Example of Adjusted Final Protective Fires
Mission with Manual Fire Direction Center.**

(2) Automated Fire Direction Centers. If the artillery FDC is automated, only the center weapon will be adjusted onto the center

grid of the FPF. The procedure is the same as for an adjust-fire mission. (See figure 5-27.) All corrections are automatically applied to the other weapons without firing. Note that “end of mission” ends the adjustment phase. “Cancel FPF” is used to terminate the FPF.

Example

“Right 20, drop 50, end of mission, over.”

“H12 this is H18, adjust fire, over.”

(FDC reads back.)

“Grid 5784 4893, altitude 475, over.” (Encoded when not radio encrypted.)

(FDC reads back.)

“Final protective fire, attitude 1900, danger close, VT, over.”

(FDC reads back.)

(The unit fires one round with a selected howitzer. The FO observes and corrects the round just as in adjust-fire missions. The round represents the center of the linear sheaf.)

“Direction 0810, left 80, drop 50, over.”

(FDC reads back.)

(The unit fires the adjustment, and the FO believes that he can make a final correction to within 50 meters of the FPF line.)

“Right 20, drop 50, end of mission, over.”

(FDC reads back.)

(The FDC processes this adjustment but does not fire. Data is then determined for all howitzers. The data is passed to all howitzers, which remain laid on the FPF when not engaged in other missions.)

Figure 5-27. Example of Adjusted Final Protective Fires Mission with Automated Fire Direction Center.

c. Nonadjusted Final Protective Fires. In some instances, the tactical situation dictates against adjusting the FPF. In these cases, it is essential for the FDC to be automated. If this is not possible, then the observer should consider the proximity of the FPF to

friendly troops. The FO will then establish the FPF and give the FPF location, including altitude and attitude. (See figure 5-28.)

“H12 this is H18, fire for effect, polar, over.”
(FDC reads back.)
“Direction 3160, distance 400, down 20, over.” (encoded when not radio encrypted)
(FDC reads back.)
“Establish as final protective fire, attitude 1900, danger close, delay, over.”
(FDC reads back.)
(The FDC processes the mission and transmits data for the guns to lay on without firing.)

Figure 5-28. Example of Nonadjusted Final Protective Fires Mission.

d. Laser Final Protective Fires. Laser FPFs are nonadjusted FPFs. They are similar to laser draw missions with one major difference—unlike laser draw missions, the lased points of the FPF each represent a howitzer aim point. The number of aim points must match the number of howitzers. Note that it is possible to create gaps in the FPF “wall of steel” with a laser FPF. Each point is lased and transmitted to the FDC as polar data or converted to a grid. (See figure 5-29 on page 5-79.)

“H12 this is H18, fire for effect, laser draw, over.”
(FDC reads back.)
“Direction 1562, distance 380, vertical angle plus three, over.” (Encoded when not radio encrypted.)
(FDC reads back.)

(Direction, distance, and vertical angle to remaining points are transmitted and read back by FDC.)

“Establish as final protective fire, danger close, VT, over.”
(FDC reads back.)

(The FDC processes the mission and transmits data for the guns to lay on without firing.)

Figure 5-29. Example of Laser Final Protective Fires Mission.

Section IX. Nonstandard Procedures for Artillery and Mortars

5901. Adjustment of Fires by Sound. During operations in which FO visibility is limited, fire may be adjusted by the use of sound alone. Target location may be reported to the FO by the supported unit or may be determined by the FO. If the FO can hear noises at the enemy position (e.g., weapons firing, vehicles, or troop movements), he can estimate a direction and distance from his position.

a. Procedures. The FO must alert the FDC when he is going to adjust by the use of sound. The FO must determine his location and ensure that the battery FDC has it plotted. The FO then determines the direction to the target and selects a target grid along the direction to the target. He then sends a call for fire using that direction and target grid. On hearing the burst of the adjusting round, the FO estimates the direction to the burst and compares it with the direction to the target. The FO converts the deviation to a lateral shift in meters. Distance to the adjusting point is difficult to judge; therefore, the FO may have to use creeping techniques to

adjust onto the target. The FO can determine distance by measuring the time it takes for the sound of the burst to reach him and multiplying the time interval by the speed of sound (350 meters/second). To help the FO determine distance accurately, the FDC must announce the precise moment of impact, for example, “splash.”

b. Employment Considerations. The following should be considered when adjusting fires by sound:

- The FO must exercise caution in very broken terrain. In hills or mountains, the sound may travel around a hill mass before it arrives at the FO’s position and may produce a false direction to the burst.
- If the FO’s position is inaccurate, the initial round will be inaccurate. The initial round can be used to determine a resection.
- The FO may consider using a WP round with a 200-meter HOB as the first round in adjustment.
- To increase accuracy in adjustments using sound, the FDC may take the adjustments from two or more FOs.
- Aerial observers may be used to assist the ground observer in making adjustments.

5902. Multiple Missions. Contact with the enemy may be so intense that the FO must transmit two or more calls for fire and

adjust all missions simultaneously. When this situation occurs, the FO should take the following steps:

- Consult the maneuver unit commander, if possible
- Consider previous guidance on target priorities and mission precedence
- Use his own judgment to determine which of several important targets should be engaged first
- Use target numbers assigned during the MTO; this will help the experienced FO with handling multiple missions.

The FO may also record the corrections determined for each target to eliminate any confusion that may arise in the heat of the battle. If other FOs are using the same COF net, then each FO should continue to use his call sign during the mission.

5903. Auxiliary Adjusting Point. To achieve surprise, the FO may decide not to adjust directly on the target but to adjust on a nearby point. This nearby point, which is the auxiliary adjusting point, must be far enough from the target (at least 500 meters) to obscure the real purpose of the adjustment. (See figure 5-30 on page 5-82.) Also, the auxiliary adjusting point must be selected so that an accurate shift to the target can be determined (preferably lateral). When the adjustment on the auxiliary adjusting point is complete, the shift to the target is made.

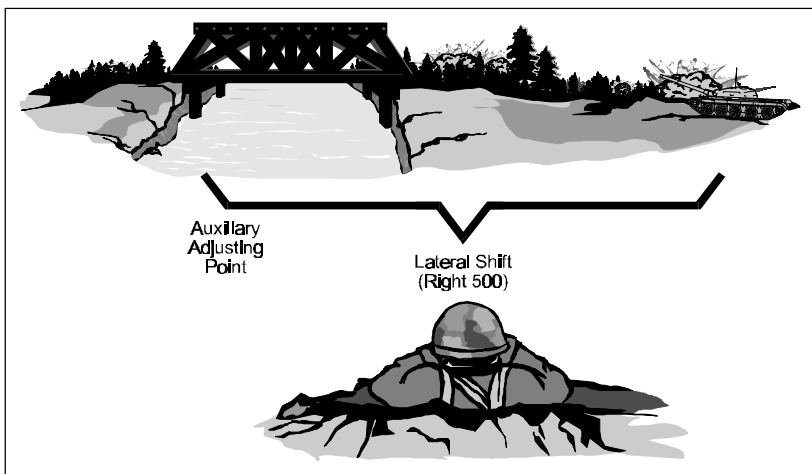

Figure 5-30. Auxiliary Adjusting Point.

5904. Disoriented Observer. Poor visibility, unreliable maps, deceptive terrain, or rapid movement through unfamiliar terrain sometimes makes it difficult for the FO to orient himself. The FO may call for marking round(s) to be fired on a known point, previously fired target, or prominent terrain feature.

Example
"Mark hill 37."

As a last resort, the FO may call for a round or rounds to be fired into the center of the target area.

Example

"Mark center of sector."

The FO usually requests a type of projectile that is easily identifiable (such as WP), or he can request a higher burst with HE or WP. The unit may have an SOP for shell/fuze combinations. The FDC prepares data that will place the round at the point requested by the FO. If the FO fails to see the round, the FDC prepares data that will move the next round to a different point of impact or that will raise the burst higher in the air. This procedure is continued until the FO positively identifies the round. The FO then orders a shift from the point of impact (burst) of the identified round to a target or object that is permanent or semipermanent in nature, for example, a road junction or the ruins of a building. Once this point has been located by the adjustment of fire and has been plotted at the FDC, the observer may use it as a known point from which shifts can be made to subsequent targets.

5905. Irregular-Shaped Targets. When calling for fire on an irregular-shaped target, the FO must request the appropriate sheaf or describe the target in sufficient detail to allow the FDO to decide how best to attack the target. Choices include circular, linear, rectangular, and laser-drawn targets. For large targets that warrant multiple batteries or battalions, the target is segmented so that individual batteries provide coverage for a portion of the target.

a. Circular Sheafs. Circular sheafs may provide the best coverage of an irregular target area. The circular sheaf is the default sheaf for automated FDCs (100-meter radius). With a single battery, aim

points are placed half the distance from the center grid and radius edge. Large targets are segmented for multiple units.

b. Linear and Rectangular Targets. Linear and rectangular targets require orientation in terms of direction. The FO sends the grid, size, and attitude of the target. The grid is the location of the center of the target. The size is the length and width of the target. The target attitude is described as a clockwise angle, in mils, measured from grid north to a line passing through the long axis of the target. (See figure 5-31.) Attitude is sent to the nearest 100 mils and is always less than 3,200 mils.

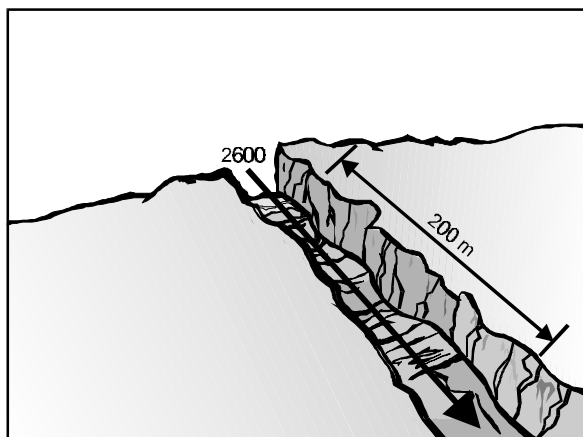

Figure 5-31. Target Attitude.

c. Laser-Drawn Targets. The MULE, or oriented BC scope with laser rangefinder, allows irregular targets to be “drawn,” or traced by the observer. The BCS or Initial Fire Support Automation

System (IFSAS) then determines the best distribution to cover the target area. The number of lased points does not correspond to howitzer aim points and therefore does not need to equal the number of howitzers firing (as with the laser-drawn FPF). With a single battery, the first and last lased points are the only points that are also aim points for howitzers. All other howitzer aim points are equally distributed over the target (nonlinearly). A laser draw mission can be used to create linear or rectangular targets by simply lasing two points and announcing the appropriate width.

5906. Emergency Observer Procedures. In an emergency situation in which an FDC is not available, the FO may determine and send fire commands directly to the battery. This technique is applicable only to the experienced FO. Initial data is determined by use of the following steps.

a. Step One. Estimate the range from the battery to the target.

b. Step Two. Determine the M3A1 green bag charge by use of the following rule: Charge equals range in thousands (155 mm).

<p style="text-align: center;">Example (155 mm) Range 5,000 equals charge 5.</p>

c. Step Three. Determine the deflection to the target by converting the azimuth to the target into deflection. You must know the battery azimuth of lay.

d. Step Four. Use an elevation of 240 mils (announced as quadrant 240 mils) to fire. A subsequent correction for range may need to be applied before the first round.

e. Step Five. Make subsequent corrections as required.

(1) Determine $100/R$, where $100/R$ equals the number of mils required to move the burst laterally (deflection) or vertically (HOB) 100 meters. $100/R$ equals 100 divided by the range in thousands to the nearest hundred. (Range 4,600: $100/R = 100 \div 4.6 = 21.7 \gg 22$.)

(2) Determine correction in deflection in relation to the GTL. Correction in deflection, in mils, equals the change in meters (divided by 100) times $100/R$ (left add, right subtract (LARS)). (A correction of R120 = $120 \div 100 = 1.2 \times 22$ ($100/R$) = $26.4 \gg 26$ mils.)

(3) Determine the change to quadrant elevation (QE) that will give a 100-meter range change (C-factor). (See table 5-9 on page 5-87.) A change in QE is expressed in mils. Range change is expressed in hundreds of meters times the C-factor.

(4) Determine the initial fuze setting by estimating TOF during adjusting rounds.

(5) Adjust the HOB by using a C-factor of two divided by initial fuze setting for the change in HOB (up subtract, down add).

Example

Estimated TOF (fuze setting) = 16 sec; results in graze burst.

Correction up 40.

$2 \div 16 = 0.125$; 40 (HOB correction) $\div 10$ m (HOB) = 4 corrections;

up = subtraction from previous fuze setting.

$0.125 \times 4 = 0.5$ sec subtracted from 16.0 = 15.5; announced "time 15.5."

Table 5-9. Artillery C-Factor.

Weapon	C-Factor
155 mm (M198, M109)	11 minus charge

(reverse blank)

Chapter 6

Naval Gunfire Special Situations

This chapter applies to special situations that are unique to NGF. These NGF procedures are used in conjunction with those discussed in chapter 4.

6001. Illumination. Battlespace illumination facilitates observation for both the spotter and the combat unit and restricts the enemy's freedom of movement. Illumination shells can be used to illuminate areas of suspected enemy activity, to provide illumination during adjustment of night fire missions, and to harass the enemy. There are two methods of employing illumination: continuous and coordinated.

a. Continuous Illumination. Continuous illumination will automatically be used during the fire-for-effect phase of coordinated illumination missions. It may also be used in surveillance missions. When firing continuous illumination, the ship will fire one round approximately every 15 seconds; this will result in one round bursting, one flare at midpoint of descent, and one flare near burnout. This technique should be used with discretion to avoid wasting the limited number of star shells (illumination projectiles) available in the ship's magazine.

b. Coordinated Illumination. Coordinated illumination is the common technique used by NGF spotters to adjust fire during darkness. The spotter will transmit a call for fire for a suspected

target, the location of which is not sufficiently accurate to fire for effect. The ship will fire an illumination round over the initial target location. The spotter will then move the illumination by subsequent adjustments. When the flare is adjusted to provide good target illumination, the spotter will inform the ship of the moment of best illumination by transmitting the command “stand by, mark.” The ship will then compute gun data to fire the initial round for HE adjustment to impact directly under the point of illumination burst at the moment of best illumination. There will be a single salvo of illumination fire for each adjustment. When fire for effect begins, the ship will fire adequate continuous illumination to ensure that the spotter can see the target.

c. Illumination Call for Fire. The spotter uses the standard call for fire format. The spotter announces either “continuous illumination” or “coordinated illumination” in the special instructions subelement of the call for fire. The number of guns is omitted because one gun is standard. The ammunition (illumination projectile and fuze) is also omitted. The mission may require reduced charge to prevent ripped chutes, particularly when firing at ranges of less than 7,000 meters. The following is an example of a coordinated illumination call for fire.

Example

Spotter: “AIB this is C2D, fire mission, target number AF 1011, over.”

Spotter: “Grid 344 677, altitude 55, direction 2680, suspected enemy activity, coordinated illumination, over.”

d. Prefiring Report. To differentiate between the illumination trajectory and the trajectory to be used for subsequent HE, the ship

announces “line of fire,” followed by “ready” and a TOF for the illumination projectile. The spotter must consider the path of the empty canister and its probable impact point along the line of fire. The spotter reads back the prefiring report and commands “fire.”

e. Illumination Adjustment Procedures. Spottings are made to determine the location of the flare at the midpoint of descent and the height of burnout of the flare. The flare is normally corrected to position it over (behind) the target along the OTL to achieve a silhouette of the target. If the target is on a slope, the flare will normally be positioned short of the target to allow the light to shine back onto the target. The direction and speed of the wind will also affect the positioning of the flare.

(1) Deviation and Range Corrections. These corrections are given in multiples of 100 meters; the minimum correction is 100 meters. Because the illuminated area is large, bold corrections are normally used instead of bracketing.

(2) Height of Burnout. The height of burnout should be between zero (as it touches the deck) and 50 meters above the deck. Corrections are given in multiples of 50 meters, with a minimum correction of 50 meters. If the *flare burns on the deck*, the spotter counts the number of seconds that it burns, multiplies this by the rate of descent, and rounds up to the nearest 50 meters. For the five-inch illumination projectile, the rate of descent is 10 meters per second.

Example

A flare burns on the deck for four seconds. The correction is "up 50."
(4 sec x 10 m/sec = 40 (round up to 50))

If the *flare burnout is in the air*, the spotter must determine the height of burnout. This can be done by using binoculars (mils x OT factor). A second technique involves counting the number of seconds that it takes the flickering ember from the flare to reach the deck and multiplying that number by the rate of descent. After rounding down to the nearest 50 meters, a correction is given to cause the height of burnout to be between zero and 50 meters.

Example

A flare burns out in the air. The spotter counts seven seconds from the burnout until the ember touches the deck. The correction is "down 50."
(7 sec x 10 m/sec = 70 (round down to 50))

f. Continuous Illumination Procedures. The spotter will adjust the illumination as discussed above. Once the target has been properly illuminated, the spotter can then begin the fire-for-effect phase of the mission. In the fire-for-effect phase, the ship will fire illumination projectiles at a certain rate of fire to keep the target area continuously illuminated. The spotter may increase or decrease the rate of fire by ordering an interval or sustained fire. The following are examples of entering the fire-for-effect phase.

Examples

“10 salvos, fire for effect, over.” (The ship determines the rate of fire.)

“Sustained fire, five minutes, fire for effect, over.”

“10 salvos, interval 10, fire for effect, over.”

When the spotter desires to terminate illumination early during the fire-for-effect phase, he should transmit “cease illumination.” If the spotter acquires a target during a continuous illumination mission and desires to change to coordinated illumination, he should transmit the command “coordinated illumination.” This command is followed by any desired illumination corrections, target description, method of engagement, and method of control changes.

Example

“Coordinated illumination, left 200, troops in the open, fuze CVT in effect, over.”

The ship will fire one illumination projectile and be prepared to mark. Coordinated illumination procedures are described below.

g. Coordinated Illumination Procedures. The spotter’s request for coordinated illumination may result from acquiring a target during a continuous illumination mission or may be a part of the spotter’s method of engagement in the initial call for fire. The request for coordinated illumination alerts the ship that the spotter will adjust the illumination and will subsequently request and adjust HE projectiles timed to impact at the moment of best illumination. During the illumination adjustment phase of the mission, the ship will time every illumination projectile fired and will be prepared to

mark when commanded by the spotter. The spotter will adjust the illumination onto the target area by using the procedures outlined previously.

(1) Establishing the Mark. Once the illumination flare has been positioned to yield the optimal light on the target, the spotter transmits “stand by . . . mark, over.” “Mark” informs the ship of the optimal illumination. The ship will then time the firing of each HE projectile to impact at the optimal time.

(2) Adjusting High Explosive. Immediately after receiving the readback of “mark out” by the ship, the spotter will initiate the HE adjustment phase. The spotter transmits any subsequent corrections to improve the accuracy of the initial HE salvo. If no HE correction is sent, the ship will fire the initial HE projectile at the point of flare deployment, which may be positioned off the target location (for silhouette or wind purposes).

Examples

“HE left 200, drop 200, over.”

“HE repeat, over.”

(3) Prefiring Report. The ship will transmit a new prefiring report for the HE projectile. The spotter will read back and command “fire.” The ship will transmit “shot” for the illumination projectile and “splash, out” for the HE.

(4) Subsequent Corrections. The spotter must preface each command with the type of projectile to which the correction is to be applied.

Examples

“Illumination add 200, HE left 200, over.”
“HE add 50, 10 salvos, fire for effect, over.”

(5) Modifying the Mark. During the mission, the spotter may desire to change the timing between the illumination and the HE projectiles. To modify this interval, the spotter uses the term “advance” or “retard.” The command “advance” shortens the time of firing between the illumination projectile and the HE projectile (i.e., the ship will fire the HE round sooner). The command “retard” lengthens the time of fires between the illumination projectile and the HE projectile (i.e., the ship will fire the HE round later).

Examples

“HE left 200, advance five (seconds understood).”
“HE retard five (seconds understood).”

(6) Illumination During the Fire-for-Effect Phase. During the fire-for-effect phase, the ship will automatically fire limited continuous illumination to provide adequate illumination for surveillance. The ship will fire the last illumination projectile immediately after the last impact round in fire for effect unless the spotter commands “cease illumination” sooner.

h. Illumination Projectile Malfunctions. Two types of malfunctions are unique to illumination rounds. Ripped chutes and dark star are special procedures used by ships and spotters to compensate for these malfunctions.

(1) Ripped Chutes. As a result of high muzzle velocity at shorter ranges, flare chutes may rip or separate on deployment. Should this occur, the spotter reports to the ship “ripped chute, repeat” or “ripped chute, reduced charge, repeat.” The procedure used depends on how often ripped chutes occur and whether or not the target area can be ranged by using reduced charge. The spotter may also request that the ship increase the range.

(2) Dark Star. A dark star is an illumination round that fails to deploy or fails to ignite. Such malfunctions are caused by either faulty ammunition or improper fuze settings. When a dark star occurs, “dark star, repeat, over” is reported. The ship should immediately check its time fuze settings and note the time fuze lot being used. Additional dark stars may indicate a malfunction in the time fuze lot.

6002. Smoke. Ships can deliver only limited quantities of WP smoke, which produces rapid smoke buildup but has effects of limited duration. Early coordination with the ship will forewarn them to load the smoke ammunition in the gun turrets/mounts.

6003. Fresh Target Shift. At any time during a mission and before transmitting “end of mission,” a spotter may desire to shift fire to a higher priority target. To do this, the spotter uses the fresh target

shift technique. (See figure 6-1 on page 6-10.) The fresh target shift technique allows the ship to accomplish the shift to the fresh target more rapidly than if a call for fire with new target location data were introduced into the gunfire control computer. The fresh target shift allows the spotter to temporarily suspend the adjustment of fire for the original target, bring fire onto a higher priority target, and then resume fire on the original target, if desired.

a. Call for Fire for Fresh Target Shift. The spotter sends an abbreviated call for fire, applying a correction from the impact of the last salvo to cause the next impact to be on the fresh target. If initiated before the impact of the initial salvo, corrections are made from the target location data sent in the call for fire.

(1) Spotter Identification. Omitted.

(2) Warning Order and Target Number. Transmitted as “fresh target, target number (assign next target number).” There is no break in transmission.

(3) Target Location. Expressed as a deviation, range, and/or altitude correction from the last salvo fired. The shift is based on the original OT direction. The direction to the fresh target is not transmitted until after the first salvo of the fresh target shift has been fired and then only if it differs from the original direction by more than 100 mils or five degrees.

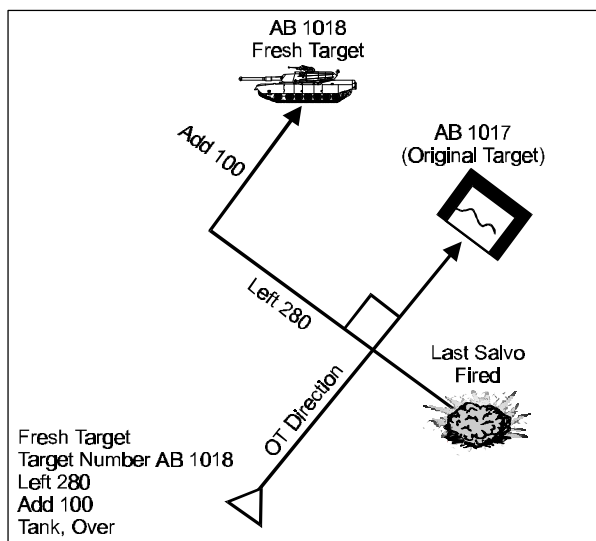

Figure 6-1. Fresh Target Shift Technique.

(4) Target Description. Must always be included.

(5) Method of Engagement. Omitted unless a change from the initial call for fire is required. Because the essence of the fresh target shift is timeliness, changes that may cause a delay, such as changes in ammunition, should be avoided. The spotter may consider using a less preferred shell/fuze combination to obtain a timely response.

(6) Method of Control. Omitted unless a change from the initial call for fire is desired. If the spotter was in the fire-for-effect phase

on the original target, the fire-for-effect phase will continue unless the spotter announces, “spotter adjust, over.”

b. Adjustment for Fresh Target Shift. Once the initial salvo for the fresh target impacts, the spotter transmits a new OT direction (if required) and conducts adjustment onto the fresh target in the normal manner.

c. Termination of Firing on the Fresh Target. The spotter continues adjustment until he has achieved the desired effects on the fresh target. If the spotter desires to resume firing on the original target, he again uses the fresh target shift technique to return to the original target. The target is referred to by its original target number.

(1) Record as Target. If the spotter wants the ship to record the target for future firing, he must transmit “record as target, target number ____” after fire for effect on that target is completed.

(2) End of Mission. When the spotter is satisfied with the effects on each of the targets (both the fresh and original targets), the mission is terminated in target number sequence. Each target must be referred to by target number when reporting the damage assessment.

Example

“End of mission, target number 17 (original target), bunker destroyed, target number 18 (fresh target), tank neutralized, over.”

6004. New Target Shift. At any time during a fire mission, the spotter may wish to attack another target that is not of a higher priority. If the ship has the capability to conduct multiple missions (multiple mounts and an MK-86 gunfire control system), the spotter can send an abbreviated call for fire without interrupting the original mission. He uses a shift from the last salvo, similar to the procedure described for fresh target shift. The spotter then conducts adjustment on both targets. The difference between the fresh target shift and the new target shift is that for fresh target shift the spotter conducts adjustment for one target at a time, while for new target shift he conducts adjustment on two targets concurrently. The call for fire and adjustment procedures for the new target shift are the same as those described for fresh target shift, with the following exceptions:

- Warning order and target number are transmitted as follows: “new target, target number (next target number).” There is no break in transmission.
- The spotter must preface each correction with the target number to which it is to be applied. If confusion will not result, the spotter may use the last two digits of the target number.
- On completion of fire for effect for the first completed mission, the spotter may record the target if desired. He completes the mission by reporting “end of mission.”

6005. Simultaneous Engagement of Two Targets. If the ship has the capability to conduct multiple missions (MK-86 gunfire control system), the spotter can adjust fire on multiple targets

simultaneously. The procedures for the simultaneous engagement of two targets differ from those of the new target shift in that the target location will not be sent by using the shift from the last salvo. The call for fire for the second target in simultaneous engagement uses the standard six-element call for fire. The spotter must preface each correction with a target number. The ship will not transmit “splash;” this will provide more time for the spotter to transmit corrections.

6006. Firing on a Recorded Target. If fires are desired on a previously recorded target or a planned target, the spotter sends an abbreviated call for fire consisting of the following elements.

a. Spotter Identification. Required.

b. Warning Order/Target Number. Consists of the words “fire mission, fire target number.” There is no break in transmission.

c. Target Location. Omitted because it is already known by the ship.

d. Target Description. Omitted unless changed from recorded description.

e. Method of Engagement. As required.

f. Method of Control. As required. When firing a recorded target from the same ship in the same firing track as when the data was recorded, a first-salvo fire for effect may be feasible.

6007. Destructive Fire. Destructive fire missions involve deliberate, accurate gunfire and normally employ a single gun against each target. This can be expensive in ammunition and can take a considerable amount of time to execute. During the mission, the gun/ammunition lot is not changed. The ship should be positioned to allow for the best conditions and orientation with respect to the GTL and the terrain in the target area.

a. Adjustment. Ship adjust should be used if possible. When the spotter conducts the adjustment, he uses normal adjustment procedures until the MPI is at the split of the 100-meter range bracket.

b. Fire for Effect. Groups of rounds, usually five for a single gun, are fired, and the average deviation and range spottings are noted. A correction is then sent based on the MPI of all the rounds. Five rounds are fired again. The correction is made to be as accurate as possible.

Example

“Right 10, drop 25, repeat, over.”

or

“Left five, repeat, over.”

6008. Massed Fire. Massed fire is “the fire of the batteries of two or more ships directed against a single target.” (Joint Pub 1-02) On occasion two or more ships will be required to engage large or important targets simultaneously. If they have not already been tasked with a direct support mission, gunfire request procedures

must be initiated. A collective call sign will be used in the request. All orders from the spotter will be read back by the senior ship. The other ship(s) will acknowledge the transmissions. The first ship to report “ready” will be adjusted onto the target in the normal manner. The other ships will be individually adjusted as they report “ready.” The spotter will address individual ships (e.g., when conducting adjustment) by using each ship’s call sign. Usually one or two bold corrections are used to bring the MPI into the required target area. To facilitate spotter control, “at my command” may be employed. At the completion of adjustment, the spotter will announce “cancel at my command, all guns (number) salvos, fire for effect, over.”

6009. Special Naval Gunfire Commands and Reports

a. Safety Considerations

(1) Check Firing. Anyone can command “check firing” when an unsafe situation becomes apparent. This command causes the ship to instantly stop firing.

(2) Cancel Check Firing. The originator of check firing must announce “cancel check firing” for the fire mission to continue.

b. From the Spotter

(1) Spreading Fires. This is a report to indicate that fires for effect are about to be distributed over an area by corrections. The spotter announces “spreading fires,” followed by a correction and the command “repeat” (pertaining to the volume of fire).